



Grandstream Networks, Inc.

GXV3500 IP VIDEO

Encoder / Decoder



This page intentionally left blank

TABLE OF CONTENTS
GXV3500 User Manual

WELCOME.....	7
SAFETY COMPLIANCES	8
FCC CAUTION	9
RF EXPOSURE INFORMATION (SAR)	9
WARRANTY	10
CONNECT YOUR GXV3500	11
EQUIPMENT PACKAGE CONTENTS.....	11
CONNECTING THE GXV3500.....	12
PRODUCT OVERVIEW	13
GXV3500 CAMERA	13
GXV3500 SPECIFICATIONS.....	16
INSTALLATION GUIDE	17
MINIMUM RECOMMENDED COMPUTER SYSTEM REQUIREMENT.....	17
CONFIGURE THE GXV3500 VIA WEB BROWSER	17
Windows Platform:.....	19
Apple Platform:	21
CONNECT TO THE CAMERA USING STATIC IP	23
GXV3500 APPLICATION SCENARIOS.....	25
BATTERY POWER OR NO NETWORK	25
LAN W/O INTERNET	25
LAN WITH INTERNET	26
GXV3500 APPLICATION PERIPHERAL CONNECTION	27
GXV3500 HOME WEB PAGE (ENCODER MODE).....	29
GXV3500 CONFIGURATION & LANGUAGE PAGE.....	30
BASIC SETTINGS EXPLANATION	31
SYSTEM SETTINGS PAGE	31
VIDEO & AUDIO SETTING PAGE	33
NETWORKING SETTING PAGE	35
DDNS SETTINGS PAGE	36
SIP SETTING PAGE.....	37
STATUS PAGE.....	40
ADVANCED SETTINGS EXPLANATION	41
USER MANAGEMENT PAGE.....	41
MAINTENANCE PAGE.....	42
SMTP SETTING PAGE (EMAIL ALARM).....	44
FTP SETTINGS PAGE (UPLOAD ALARM).....	46
PTZ	47
ALARM SERVER SETTING PAGE	48
TIME LAPSE PHOTOGRAPHY	49
MOTION DETECTION.....	50
ALARM EVENT	53
SYSLOG SETTINGS.....	55
SOFTWARE UPGRADE.....	56
INSTRUCTIONS FOR LOCAL FIRMWARE UPGRADE USING TFTP SERVER:	57
CONFIGURATION FILE DOWNLOAD	57
RESTORE FACTORY DEFAULT SETTING.....	58
RESET FROM WEB INTERFACE (SOFT RESET)	58
RESET VIA BUTTON (HARD RESET).....	59
GXV3500 HOME WEB PAGE (DECODER MODE).....	61

HOME PAGE (DECODER MODE).....	61
DECODER SETTING PAGE.....	61
BASIC SETTINGS EXPLANATION (DECODER MODE).....	63
SYSTEM SETTING PAGE (DECODER MODE).....	63
NETWORKING SETTING PAGE (DECODER MODE).....	65
DDNS SETTING PAGE (DECODER MODE).....	66
SIP SETTING PAGE (DECODER MODE).....	67
STATUS PAGE (DECODER MODE).....	69
ADVANCED SETTINGS EXPLANATION (DECODER MODE).....	70
USER MANAGEMENT PAGE (DECODER MODE).....	70
MAINTENANCE PAGE (DECODE MODE).....	71
PTZ (DECODE MODE).....	73
SYSLOG SETTINGS (DECODE MODE).....	74
REMOTE ALARM_OUT PEERING WITH GXV3500 (DECODER MODE).....	75
IP SURVEILLANCE FAQ.....	79

TABLE OF FIGURES

GXV3500 USER MANUAL

FIGURE 1: GXV3500 FRONT VIEW.....	13
FIGURE 2: GXV3500 REAR VIEW.....	14
FIGURE 3: WINDOWS “NETWORK” SHOWING GXV3500 AS “OTHER DEVICES” VIA UPNP	19
FIGURE 4: “GS_SEARCH” RESULT PAGE OF GXV3500	20
FIGURE 5: APPLE SAFARI “BONJOUR” SETTING PAGE TO DISPLAY GXV3500	21
FIGURE 6: APPLE SAFARI “BONJOUR” SETTING PAGE TO DISPLAY GXV3500	21
FIGURE 7-1: APPLICATION PERIPHERAL CONNECTION FOR GXV3500	27
FIGURE 7-2: ALARM_IN AND ALARM_OUT CONNECTION CIRCUIT SAMPLE FOR GXV3500	28
FIGURE 8: HOME PAGE OF GXV3500 (ENCODER MODE)	29
FIGURE 9: WEB LANGUAGE SWITCH	30
FIGURE 10: SYSTEM SETTINGS PAGE.....	31
FIGURE 11: VIDEO & AUDIO SETTINGS PAGE.....	33
FIGURE 12: NETWORKING SETTING PAGE.....	35
FIGURE 13: DDNS SETTING PAGE.....	36
FIGURE 14-1: SIP SETTING PAGE.....	37
FIGURE 14-2: SIP SETTING PAGE.....	39
FIGURE 15: STATUS PAGE.....	40
FIGURE 16: USER MANAGEMENT PAGE.....	41
FIGURE 17: MAINTENANCE PAGE	42
FIGURE 18-1: SMTP SETTING PAGE.....	44
FIGURE 18-2: SMTP SETTING PAGE.....	45
FIGURE 19: FTP SETTING PAGE.....	46
FIGURE 20: PTZ SETTING PAGE.....	47
FIGURE 21: ALARM HTTP SERVER SETTING PAGE	48
FIGURE 22: TIME LAPSE PHOTOGRAPHY CONFIGURATION PAGE.....	49
FIGURE 23-1: MOTION DETECTION CONFIGURATION PAGE.....	50
FIGURE 23-2: MOTION DETECTION SCHEDULE CONFIGURATION PAGE	52
FIGURE 24-1: ALARM_IN ACTION CONFIGURATION PAGE	53
FIGURE 24-2: ALARM EVENT TIME SCHEDULE CONFIGURATION PAGE.....	54
FIGURE 25: SYSLOG SETTING PAGE.....	55
FIGURE 26: FIRMWARE UPGRADE AND PROVISIONING	56
FIGURE 27: FACTORY RESET FROM WEB INTERFACE	58
FIGURE 28: DECODER HOME PAGE.....	61
FIGURE 29: SYSTEM PAGE (DECODER)	63
FIGURE 30: NETWORKING PAGE (DECODER).....	65
FIGURE 31: DDNS SETTING PAGE (DECODER).....	66
FIGURE 32: SIP SETTING PAGE (DECODER).....	67
FIGURE 33: STATUS PAGE (DECODER).....	69
FIGURE 34: USER MANAGEMENT PAGE (DECODER).....	70
FIGURE 35: MAINTENANCE PAGE (DECODER)	71
FIGURE 36: PTZ CONFIGURATION PAGE (DECODER).....	73
FIGURE 37: SYSLOG PAGE (DECODER)	74
FIGURE 38: REMOTE ALARM_OUT IP CAMERA CONFIGURATION	75
FIGURE 39: REMOTE ALARM_OUT PEERING GXV3500 CONFIGURATION	76
FIGURE 40: REMOTE ALARM_OUT PEERING GXV3500 ACTION OUTPUT DISPLAY.....	77
FIGURE 41: PEERING GXV3500 DECODER ALARM_OUT CIRCUIT	78

TABLE OF TABLES

GXV3500 USER MANUAL

TABLE 1: GXV3500 TECHNICAL SPECIFICATIONS	16
---	----

This page intentionally left blank

WELCOME

Thank you for purchasing Grandstream's GXV3500, a powerful device to convert analogue camera to IP network camera (encoder mode), or display real-time stream to big screen TV (decode mode).

GXV3500 is a next generation encoder/decoder. It features cutting-edge H.264 real-time video compression, industry leading SIP/VoIP for 2-way audio and video streaming to smartphones and videophones, PoE, best-in-class scalability and ease of integration, and advanced security protection. The unique incorporation of TCP/IP protocols creates sophisticated, flexible networking and remote control abilities.



The GXV3500 features the advanced functionality of embedded analytics (motion detection). The built-in Alarm_In and Alarm_Out interface can be used to linked analogue camera, can also be peered to configured IP camera as external and remote Alarm_Out, saved the direct wiring to the camera via Ethernet network connection.

The GXV3500 can be managed with GSurf Pro (Grandstream's intuitive FREE video management software that controls up to 72 cameras simultaneously), or grouped with GVR3550/3552 Grandstream Network Video Recorder (NVR) via plug-n-play, as well as other ONVIF compliant video management systems. It also offers an advanced and flexible HTTP API and an SDK for easy integration with other surveillance systems.

Designed for indoor environment application, the GXV3500 is a robust surveillance solution for broad range of application environments such as banks, hotels, schools, retail stores and small warehouses, offices or building entrances, and other small to median sized enclosed environments.

SAFETY COMPLIANCES

These instructions are intended to assist users to safely operate the GXV3500, avoid dangerous situations or damage the device.

	
<p>Warning: May cause serious injury or death if any of the warnings below are neglected.</p>	<p>Caution: Equipment may be damaged if any of the following caution messages are neglected.</p>



Warning:

Input voltage should meet both the SELV (Safety Extra Low Voltage) and the Limited Power Source with DC 12V according to the IEC60950-1 standard. Please refer to the technical specifications for more details. Do not use a third-party power adapter or power cord. When the device installed on the wall or ceiling, make sure that it is firmly attached.



Caution:

- Make sure that the power supply voltage is correct before using the camera.
- Do not drop the device or expose it to physical shock.
- Do not expose the device to temperatures outside the range of 0 °C to 45 °C when the device is in operation.
- Do not expose the device to damp/wet conditions or high electromagnetism radiation.
- To avoid heat accumulation, make sure that your operating environment has proper ventilation.
- Do not damage the warranty sticker.

A few parts (e.g. electrolytic capacitor) of the equipment shall be replaced regularly according to their average lifetime. The average lifetime varies from the differences between operating environments and usage history. Regular maintenance checks are recommended for all users. Please contact your dealer for more details.

FCC CAUTION

Any Changes or modifications not expressly approved by the party responsible for compliance could void the user's authority to operate the equipment. This device complies with part 15 of the FCC Rules. Operation is subject to the following two conditions:

- 1) This device may not cause harmful interference.
- 2) This device must accept any interference received, including interference that may cause undesired operation.

Note: This equipment has been tested and found to comply with the limits for a Class B digital device, pursuant to part 15 of the FCC Rules.

These limits are designed to provide reasonable protection against harmful interference in a residential installation. This equipment generates uses and can radiate radio frequency energy and, if not installed and used in accordance with the instructions, may cause harmful interference to radio communications. However, there is no guarantee that interference will not occur in a particular installation. If this equipment does cause harmful interference to radio or television reception, which can be determined by turning the equipment off and on, the user is encouraged to try to correct the interference by one or more of the following measures:

- Reorient or relocate the receiving antenna.
- Increase the separation between the equipment and receiver.
- Connect the equipment into an outlet on a circuit different from that to which the receiver is connected.
- Consult the dealer or an experienced radio/TV technician for help.

RF EXPOSURE INFORMATION (SAR)

This device is designed and manufactured not to be exceeded the emission limits for exposure to radio frequency RF energy set by the Federal Communications Commission of the United States. The exposure standard for wireless devices employing a unit of measurement is known as the Specific Absorption Rate (SAR), and the SAR limit set by FCC is 1.6 W/kg.

This device is complied with SAR for general population/uncontrolled exposure limits in ANSI/IEEE C95.1-1992, and has been tested in accordance with the measurement methods and procedures specified in OET Bulletin 65 Supplement C. This device has been tested, and meets the FCC RF exposure guidelines when tested with the device directly contacted to the body. RF exposure compliance with anybody-worn accessory, which contains metal, was not tested and certified, and uses such body-worn accessory, should be avoided.

Changes or modifications not expressly approved by the party responsible for compliance could void the user's authority to operate the equipment.

Hereby, Grandstream declares that this device is in compliance with the essential requirements and other relevant provisions of Directive 1999/5/EC.

WARRANTY

If the GXV3500 was purchased from a reseller, please contact the company where the device was purchased for replacement, repair or refund.

If the device was purchased directly from Grandstream, please contact our technical support team for a RMA (Return Materials Authorization) number before the product is returned.

Grandstream reserves the right to remedy warranty policy without prior notification.



Caution:

Changes or modifications to this product not expressly approved by Grandstream, or operation of this product in any way other than as detailed by this User Manual, could void your manufacturer warranty.

Please do not use a different power adaptor with the GXV3500 because this may cause damage to the products and void the manufacturer warranty.

- This document is subject to change without notice. The latest electronic version of this user manual is available for download at:

http://www.grandstream.com/sites/default/files/Resources/gxv3500_user_manual.pdf

Reproduction or transmittal of the entire or any part, in any form or by any means, electronic or print, for any purpose is not permitted without the express written permission of Grandstream Networks, Inc.

CONNECT YOUR GXV3500

Equipment Package Contents

The GXV3500 package contains:

- GXV3500 – 1 Channel digital video encoder/decoder
- 12V DC Universal Power Adaptor
- 3.5mm to RCA audio/video cable
- Quick Installation Guide

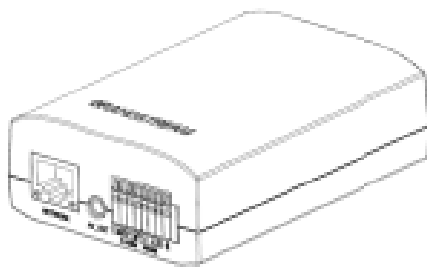

GXV 3500

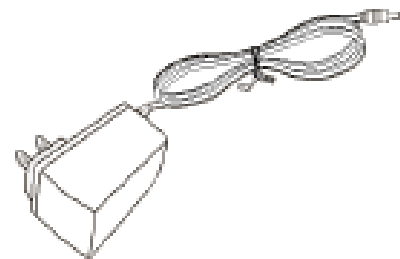

12V Power Supply

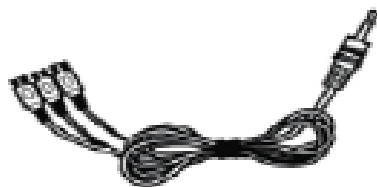

TV out RCA cable

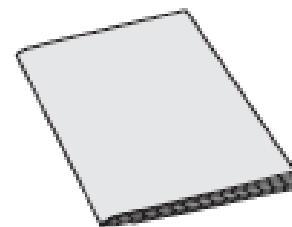

QuickStart Guide

Connecting the GXV3500

Using the Power Adapter as power supply

- Connect the RJ45 Ethernet cable to the NETWORK port of the GXV3500
- Connect the other end of the RJ45 cable to your network (switch or router or PC)
- Connect the power supply to the DC 12V power clamps on the back of the GXV3500
- Connect the GXV3500 Video In to the analog camera Video Out port via BNC cable.
- Connect 3rd party 3.5mm external microphone to “MIC_IN” port of GXV3500 if audio required.

Using PoE as power supply

- Connect the RJ45 Ethernet cable to the NETWORK port of GXV3500
- Connect the other end of the RJ45 cable to your PoE switch
- PoE injector can be used if PoE switch is not available.
- Connect the GXV3500 Video In to the analog camera Video Out port via BNC cable.
- Connect 3rd party 3.5mm external microphone to “MIC_IN” port of GXV3500 if audio required.

Please refer to following connection diagram to hook up the camera and external 3rd party accessories.

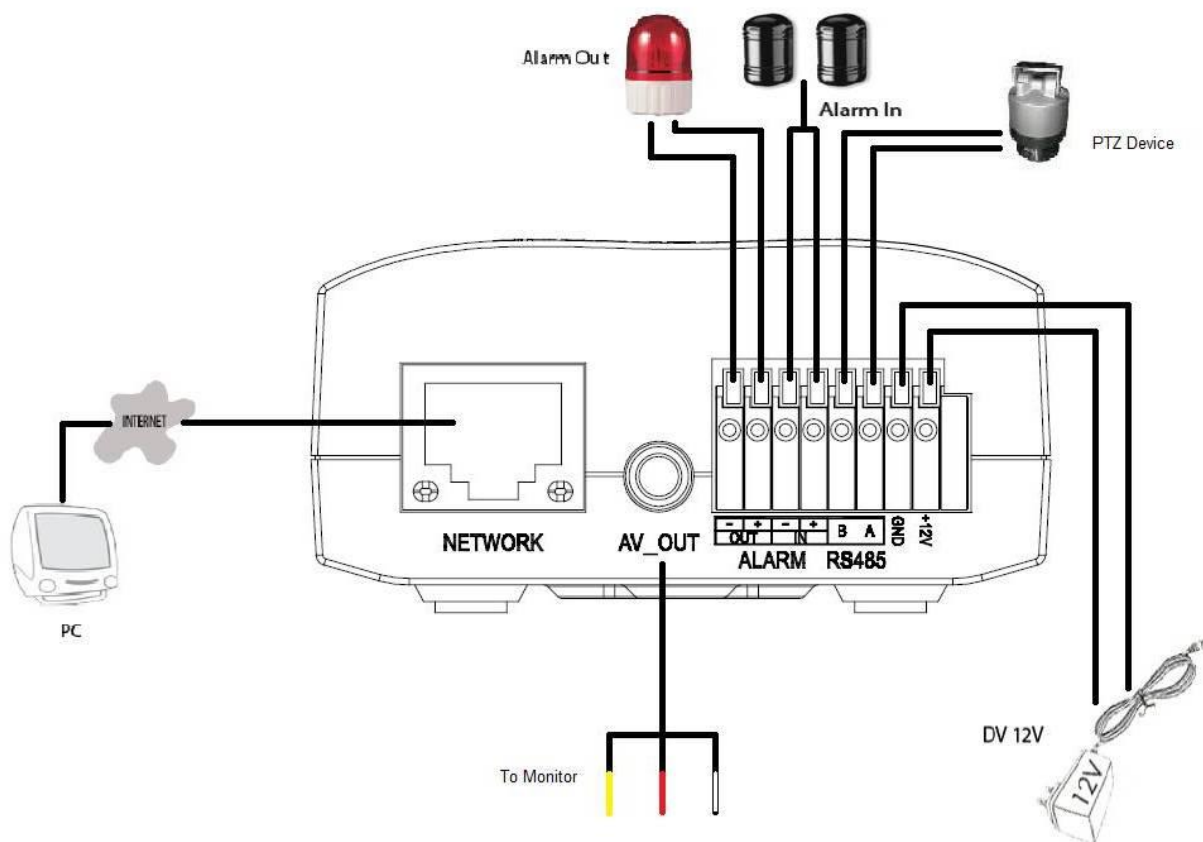

PRODUCT OVERVIEW

GXV3500 Camera

Please see below the diagram and explanation of GXV3500 IP camera:



Figure 1: GXV3500 Front View

- | | |
|---|--|
| <ol style="list-style-type: none">1. <i>V_IN, BNC Interface</i>2. <i>MIC_IN</i>3. <i>RESET</i> | <p>GXV3500 BNC interface, connect to analog camera as Video Input (Voltage: 1.0V p-p; Resistance 75 Ω)</p> <p>3.5mm socket for external 3rd party microphone input.</p> <p>PIN hole, press & hold for 15 seconds to factory reset the device.</p> |
|---|--|

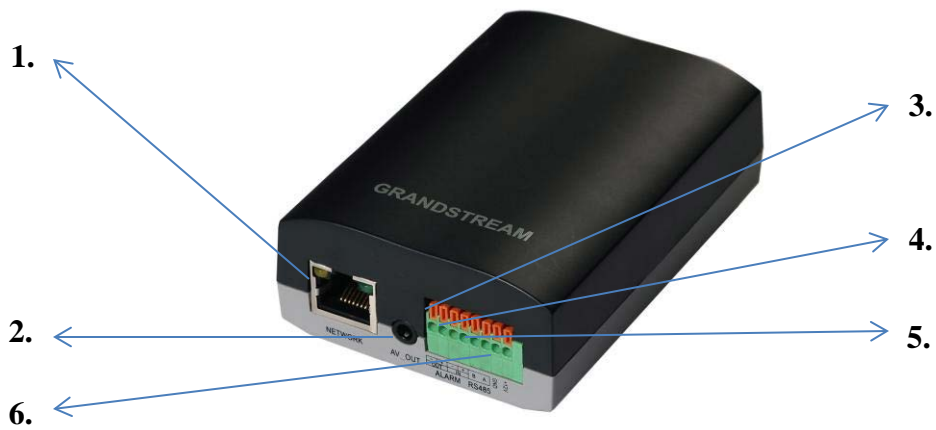

Figure 2: GXV3500 Rear View

- | | |
|---|---|
| <ol style="list-style-type: none"> 1. NETWORK 2. AV_OUT 3. ALARM_OUT 4. ALARM_IN 5. RS-485 6. DC 12 V | <p>10/100 RJ45 network socket for Ethernet connection.</p> <p>3.5mm to RCA audio/video connection output to display device like TV.</p> <p>1 Channel Alarm Output port for device like Siren.</p> <p>1 Channel Alarm Input port for device like Infrared Motion Detector.</p> <p>1 Channel RS-485 Interface for cameras with PTZ Controller.</p> <p>12V DC power port. Insert the positive bare wire +12V; insert the negative bare wire into the GND port. Do NOT connect wrongly.</p> |
|---|---|

NOTE:

- “Pin Out” of the 3.5mm AV cable used for GXV3500 (highlight in Blue)

- 1: Ground;
- 2: Video (Yellow);
- 3: Audio Right (Red);
- 4: Audio Left (White).

Same as the AV cable used in Apple iBook, etc.

3.5mm 4-Pole to RCA

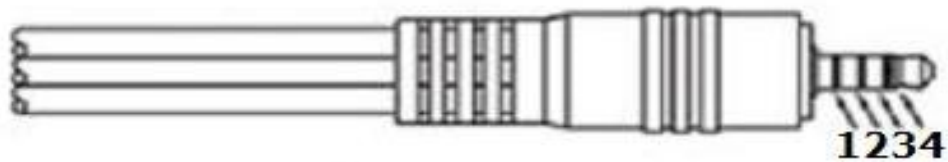

	1	2	3	4
Archos, Gigabeat, Creative Zen Vision Series, Cown iAudio, Apple iBook	Ground	■ Video	■ Right	□ Left
Standard Camcorder Cable, Topfield TFP20, Maxian T600	■ Right	Ground	■ Video	□ Left
iPod Video	■ Video	Ground	□ Left	■ Right
Zune	■ Video	Ground	■ Right	□ Left

GXV3500 Specifications

Model	GXV3500 (Encoder or Decoder)
Channel	1
Video Compression (Encoder)	H.264, MJPEG, JPEG
Video Decompression (Decoder)	H.264 ONLY
Max. Video Resolution (Encoding)	Encoding (4CIF): 704x480@30fps (NTSC); 704x576@25fps (PAL)
Max. Video Resolution (Decoding)	Decoding (4CIF): 720x480@30fps (NTSC); 720x576@25fps (PAL)
Video Bit Rate	16 Kbps ~ 2 Mbps
Video Input (Encoder Mode)	1, BNC (Voltage: 1.0Vp-p; Resistance: 75Ω)
Video Output (Decoder Mode)	1, 3.5mm to RCA Line-Out
Audio Compression	G.711 a/u (PCMA, PCMU)
Audio Input	1, 3.5mm Line In (Resistance: 1.5KΩ)
Audio Output	1, 3.5mm to RCA Line-Out (600Ω, 0.707 Vrms)
Alarm Input	1, PIN, Voltage < 15V, Current (DC) < 50mA, Normal Open
Alarm Output	1, PIN, 125VAC/0.5A, 30VDC/2A, Normal Open
PTZ Control	1, PIN, via RS-485
Embedded Analytics	Motion Detection (up to 16 target areas)
Pre-/Post-Alarm Recording	Yes
Security	On screen display, HTTPS, Password
Snapshots	Triggered upon Events, Send via email and/or FTP
SIP/VoIP Support	Yes, Voice and Video
Power over Ethernet (PoE)	IEEE 802.3af Class 0; 10M/100M Auto-sensing, 2KV Lightning Surge Protection
Network Protocol	TCP/UDP/IP, RTP/RTCP, RTSP, DHCP, DDNS, HTTP, HTTPS, SMTP, FTP, NTP
Cable Connections	BNC for Video In 3.5mm Audio Line-In RJ45 Ethernet 3.5mm to RCA Video and Audio Line-Out PINs for Alarm-In, Alarm-Out, PTZ and Power Input
Dimensions	67mm x 34mm x 96mm
Weight	121g or 4.3oz
Temperature / Humidity	Operating: 0°C ~ +45°C (32°F ~ 113°F), 10 – 90% RH (Non-condensing) Storage: -20°C ~ +60°C (-4°F ~ 140°F)
Power Adapter	Output: 12VDC/0.5A; Input: 100–240VAC, 50–60Hz
Compliance	FCC Part 15, Subpart B Class B; EN 55022 Class B, EN 61000-3-2, EN 61000-3-3, EN 55024, EN 60950-1; RCM AS/NZS CISPR 22/24, AS/NZS 60950

Table 1: GXV3500 Technical Specifications

INSTALLATION GUIDE

Minimum Recommended Computer System Requirement

To install GXV3500, you have to have a computer, PC recommend.
The minimum recommended PC system requirement listed below:

- Windows XP, Windows Vista, Windows 7 and Windows 8
- CPU: Intel Pentium 4 or higher, 2 GHz
- RAM: 2 GB (4 GB recommended for larger systems)
- Support for DirectX 8.0 and above.

Configure the GXV3500 via Web Browser

The GXV3500 has embedded Web server to respond to HTTP GET/POST requests. Embedded HTML pages allow user to configure the IP camera through Microsoft Internet Explorer (7.0 or above), Firefox, Chrome (plug-in from Grandstream required).

- Download WebControl Plug-in from Grandstream website:

http://www.grandstream.com/products/tools/surveillance/webcontrol_plugin.zip

NOTE:

- *Please temporarily disable Antivirus or Internet Security Software when download and install the Grandstream WebControl Plug-in for Firefox/Chrome or “GSViewerX.cab” for Microsoft Internet Explorer. Please close Browser to install the downloaded Plug-in or Active-X.*
- *Please trust and install the file downloaded if prompted by the Antivirus or Security software.*
- **For Apple platform (OS-X or iOS), only MJPEG (video encode mode) supported currently.**

This page intentionally left blank

Connect the Camera to network with DHCP server (Recommended)

The GXV3500 by default enabled as DHCP client, it will automatically get IP address from the network with DHCP server running.

WINDOWS PLATFORM:

There are two ways for Windows user to get access to the IP Camera easily:

A. UPnP

By default, the GXV3500 has the UPnP feature turned ON. For customers using Window network with UPnP turned on (most SOHO router support UPnP), it is very easy to access the IP camera:

- Find the “Network” icon  at Windows Desktop.
- Click the icon to get into the “Network” and the IP cameras will list as “Other Devices” shown like below. Refresh the pages if nothing displayed. Otherwise, the UPnP may not active in the network.

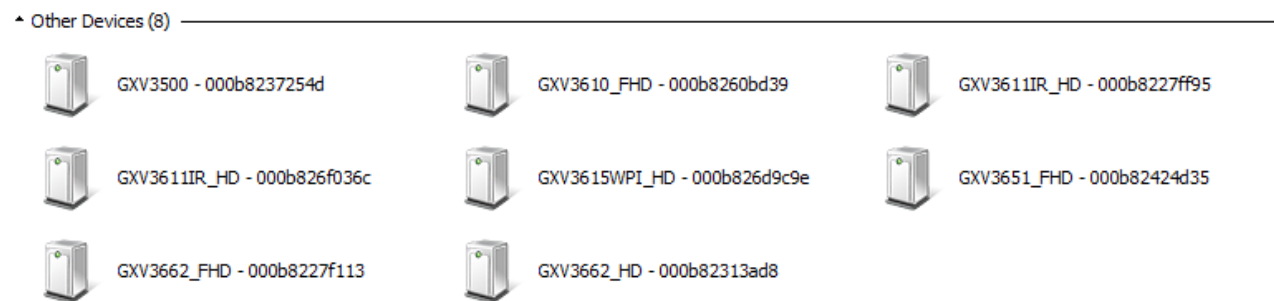



Figure 3: Windows “Network” showing GXV3500 as “Other Devices” via UPnP

- Click the displayed icon of related IP camera, the default browser (e.g.: Firefox or Chrome) will open and connect directly to the camera’s webpage, prompt message will display asking for plug-in installation.
- Disable security or antivirus software, download the plug-in, close browser and install the plug-in, open the browser again, the embedded video will be displayed if clicking the icon of the related IP Camera.

B. “GS Search” Utility Tool

User can know the IP address assigned to the camera from DHCP server log or using the Grandstream GS_Search tool. Following is the instruction for using “GS_Search” utility tool:

1. Download the GS_Search tool from Grandstream website:
http://www.grandstream.com/products/tools/surveillance/GS_Search.zip
2. Run the Grandstream GS_Search tool by double click the unzipped “GS_Search.exe”.
3. Click on the  button to begin device detection
4. The detected devices will appear in the output field like below

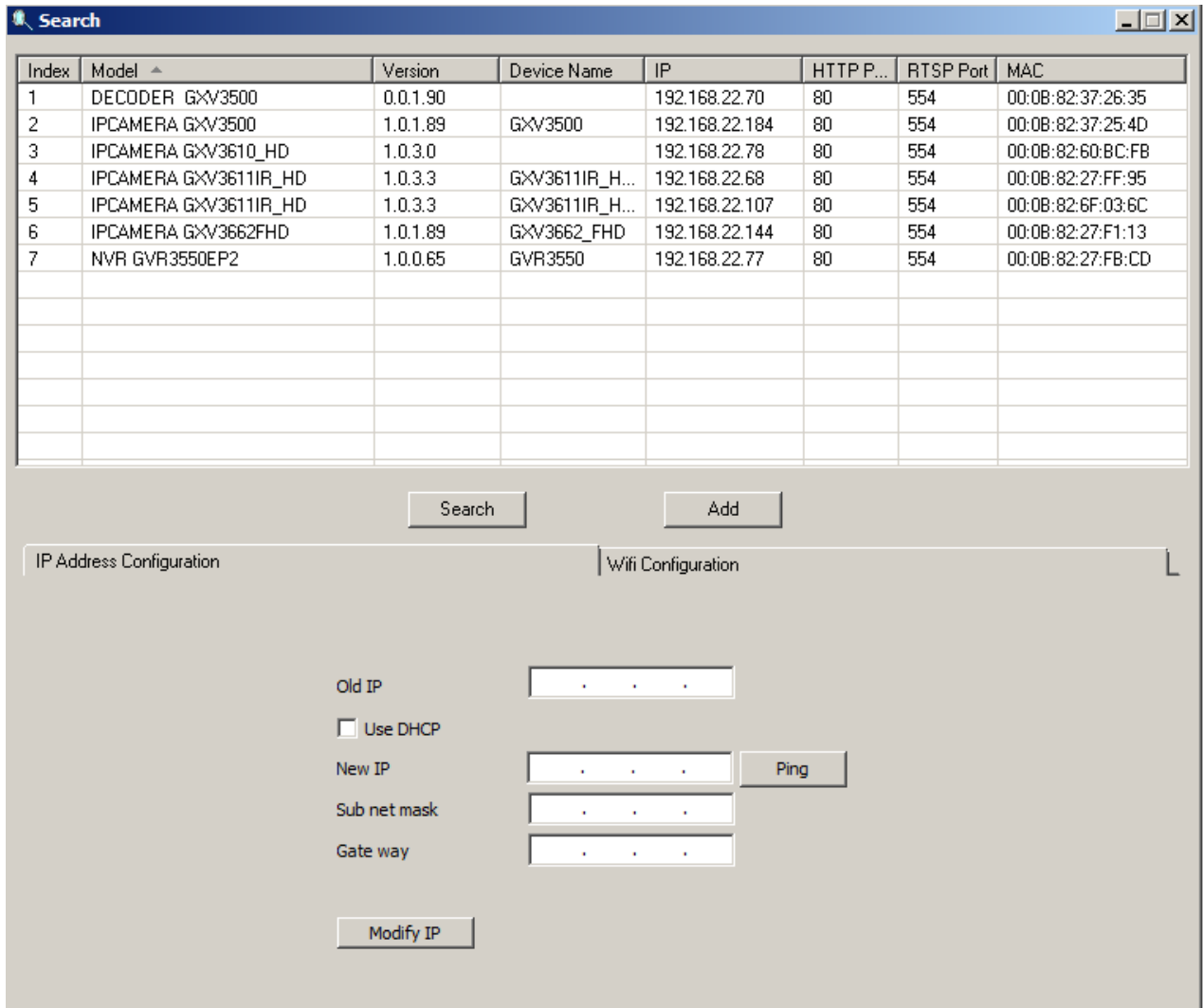

Figure 4: “GS_Search” Result Page of GXV3500

5. Double click the column of the detected camera, the browser will automatically open and link to the device IP and the web configuration page.
6. The browser will ask for plug-in or ActiveX if not installed, otherwise it will get to Home page and start to show the video captured by the camera (by default the camera enabled anonymous access)
7. Click “Configuration” icon, the browser will ask credentials to authorize configuration.
8. Enter the administrator user name and password to access the Web Configuration Interface, the default user name and password are both set to **admin**.
9. In step 6, browser will indicate that “This website wants to install the following add-on: GSViewerX.cab from Grandstream Networks Inc.” Please allow the installation.
10. The plug-in can be download here:

http://www.grandstream.com/products/tools/surveillance/webcontrl_plugin.zip

APPLE PLATFORM:

For Apple users, please turn on Bonjour of Safari to find and access the GXV3500.

- 1) Open Safari, select “Advanced” to open the Advanced Setting.
- 2) Click “Include Bonjour in the Bookmarks menu” and “Include Bonjour in the Favorites bar” then close the setting page and back to Safari.

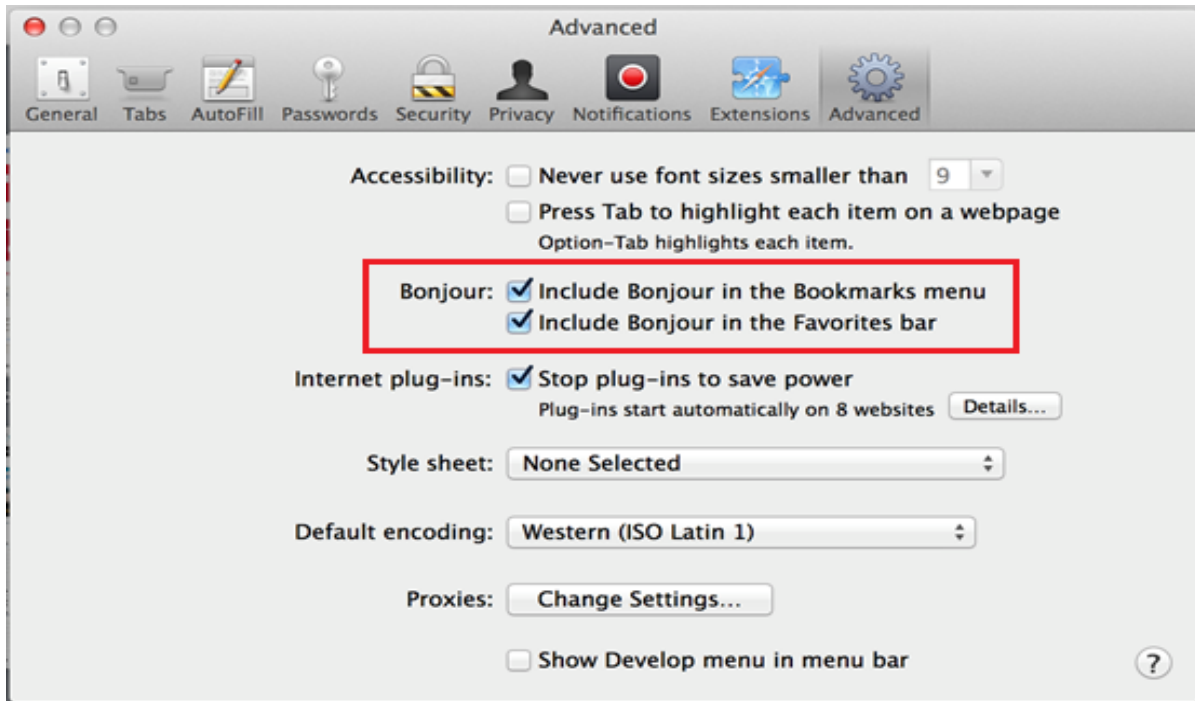

Figure 5: Apple Safari “Bonjour” Setting page to display GXV3500

- 3) Bonjour will now display embedded at Safari. Select “Bonjour” pull-down menu and select “Webpages”, the related IP Camera like GXV3500 will be there.

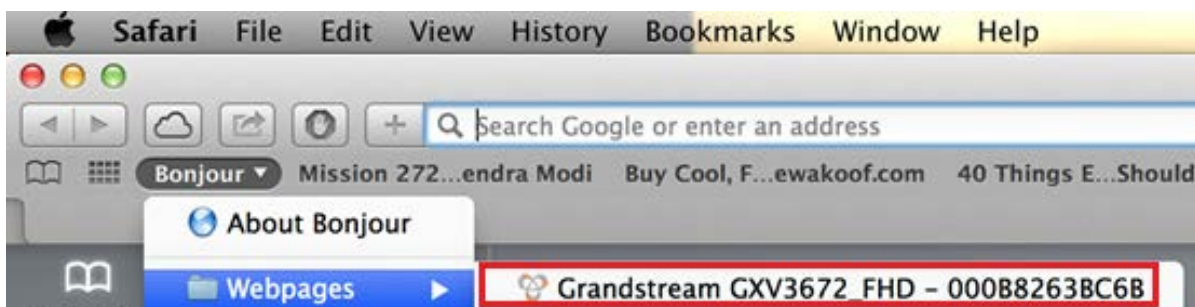

Figure 6: Apple Safari “Bonjour” Setting page to display GXV3500

- 4) Click the displayed camera to access to the configuration page of the camera.

- 5) To see the video, user has to change the video codec from default H.264 to MJPEG, and type in following to URL:

http://IP_Address_Camera:Port/mjpeg/mjpegX.html

(X: 0, 4 represent 1st, 2nd stream, Default Port: 80)



NOTE:

- The instruction given here based on Safari/OS-X, other Apple platform like iOS (iPhone/iPad) can use similar method.



- iPhone/iPad (iOS) users are recommended to use Applications in Apple Store.
- Free or Paid applications from Apple Store like “IP Cam Viewer” are suggested and verified working with Grandstream IP Cameras like GXV3500.
- Apple Store applications like “IP Cam Viewer” will support H.264 video codec.

Connect to the Camera using Static IP

If no DHCP server in the network, or the camera does not get IP from DHCP server, user can connect the camera to a computer directly, using static IP to configure the camera.

The default IP, if no DHCP server; or DHCP offer time out (3 minutes), is **192.168.1.168**

1. Connect the computer network port via an Ethernet cable directly to the IP camera GXV3500.
2. Configure the computer using Static IP: 192.168.1.XXX (1<XXX<255, but NOT 168) and configure the “Subnet mask” to “255.255.255.0”. Leave the “Default Gateway” to “Blank” like below: (Example of Windows platform, Apple platform is similar)

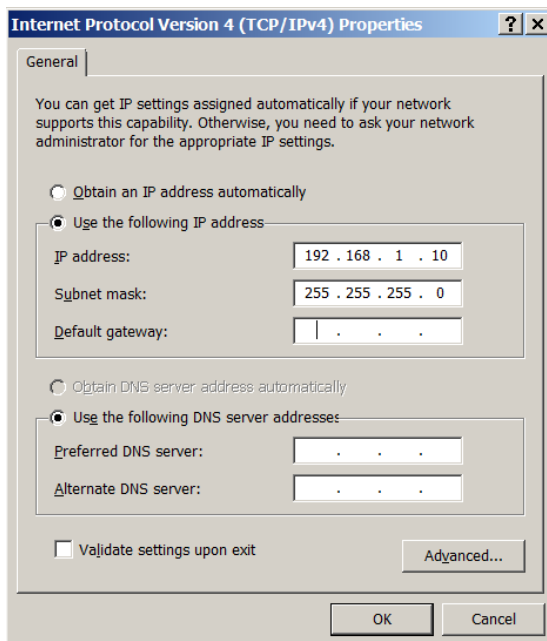

3. Power on the GXV3500.
4. Start the browser when the network connection is up.
5. Enter 192.168.1.168 in the address bar of the browser.
6. The browser will ask for plug-in or ActiveX if not installed, otherwise it will get to Home page and start to show the video captured by the camera (by default the camera enabled anonymous access)
7. Click “Configuration” icon, the browser will ask credentials to authorize configuration.
8. Enter the administrator user name and password to access the Web Configuration Interface, the default user name and password are both set to **admin**.
9. In step 6, IE will indicate that “This website wants to install the following add-on: GSViewerX.cab from Grandstream Networks Inc.”, allow the installation.
10. Firefox, Chrome user need to download and install the plug-in to see the video, the plug-in is here: http://www.grandstream.com/products/tools/surveillance/webcontrl_plugin.zip

NOTE:

- *Please temporarily disable Antivirus or Internet Security Software and close all browsers when download and install the Grandstream Plug-in Software.*

This page intentionally left blank

GXV3500 APPLICATION SCENARIOS

GXV3500 is a very versatile indoor device, it can be used in a lot of scenarios.

Battery Power or No network

For environment like remote warehouse/storage, grocery store, small (take-out) restaurants, the GXV3500 will meet your very basic surveillance requirement

This is idea solution to upgrade the traditional standalone CCTV security system, while leave the potential of operating it in IP network when the network is available. All you need is power (could be battery) , network wiring is not necessary required and can leave to future upgrade when it available.

Product	Power Adapter Model			POE Model			Class Advertisement (IEEE 802.3af)
	Standby	Operating	Max Power	Standby	Operating	Max Power	
	Power(W)	Power(W)	Power(W)	Power(W)	Power(W)	Power(W)	
GXV3500	1.49	1.55	1.60	1.93	1.98	2.05	0

Equipment List:

- 1) GXV3500
- 2) Ethernet cable and PoE injector (Optional)

Depending on the space monitored, one or several GXV3500 may be required.

LAN w/o Internet

For multi-room or a bigger space, multiple GXV3500 might be required. User can establish a local area network using PoE switch.

If remote access required, a router with internet access may add in.

Equipment List:

- 1) Several GXV3500
- 2) Ethernet cables
- 3) Switch (Static IP required to configure to IP Cameras)
- 4) PoE Switch (Optional, better solution)

If remote access to the cameras required to view the LIVE video stream, then broadband Internet is required and more equipment required:

- 5) Router (if DHCP configured than static IP is not required although still recommended)
- 6) Broadband Internet Access (FiOS, Cable or DSL)
- 7) iPhone or Android phone.

LAN with Internet

For multi-room or a bigger space, with Internet access and local video recording required, following list is recommended:

Equipment List:

- 1) Several GXV3500
- 2) GVR3550/2 NVR
- 3) Ethernet cables
- 4) Switch (PoE Switch recommended)
- 5) Router
- 6) Broadband Internet Access (FiOS, Cable or DSL)
- 7) iPhone or Android phone
- 8) GSurf_Pro Remote Access (Optional)

GXV3500 Application Peripheral Connection

Below is the illustration of GXV3500 peripheral connections for related application.

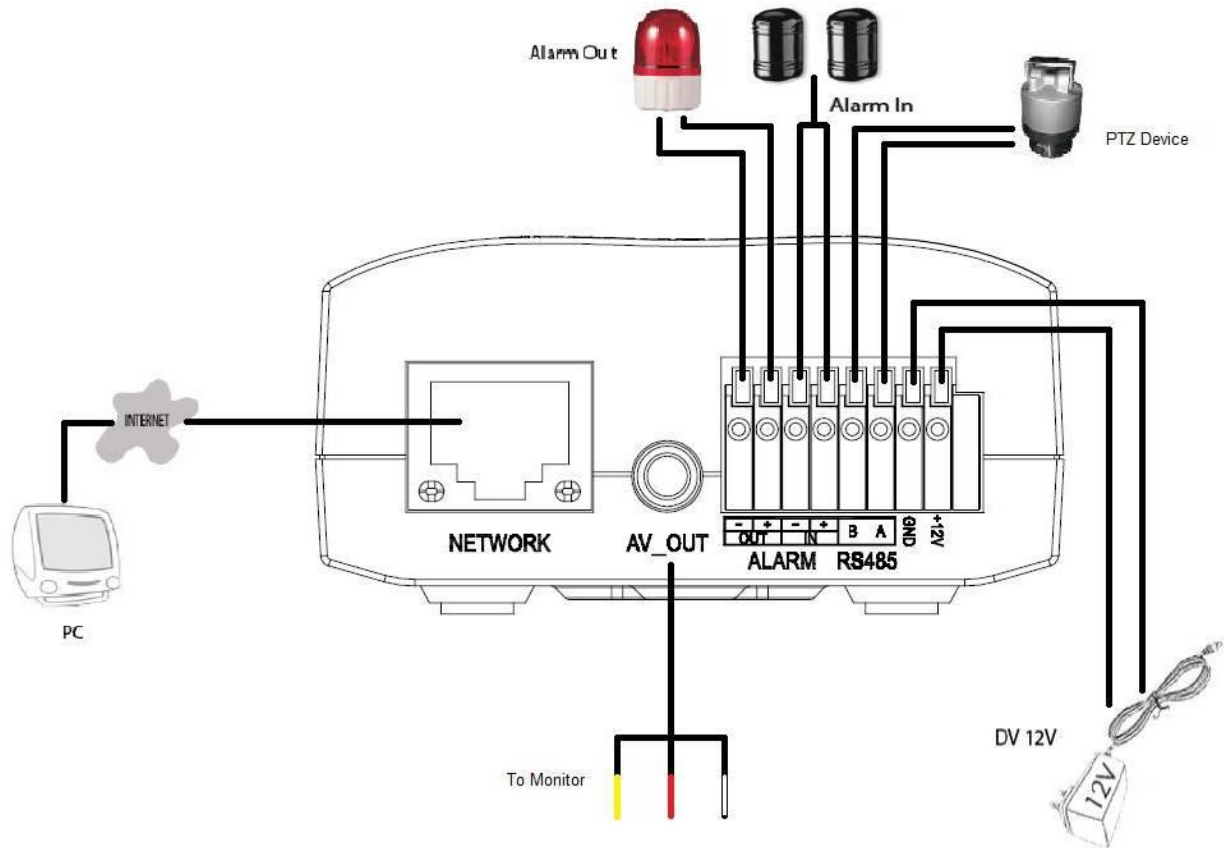

Figure 7-1: Application Peripheral Connection for GXV3500

NOTE:

- For days of video storage, please use Motion Detection Event Video Recording, or using Grandstream GVR3550/2, or GSurf_Pro VMS.
- Alarm_In could use any 3rd party Sensors (like IR Motion Sensor) or Intercom Push Button, etc.
- Alarm_Out device could use 3rd party Siren and Strobe Light, or Electric Door Striker, etc.
- Audio Input (Microphone) and Audio Output (Amplified Speaker) using 3.5mm interface and must match below impedance parameter:

Audio Input	3.5mm Line-In (1.5KΩ)
Audio Output	3.5mm Line-Out (600Ω, 0.707 Vrms)

- Grandstream Video Phone can work with GXV3500 via either Peer IP (LAN) or SIP extension (WAN).
- Peer to Peer (or Direct IP) works only at LAN using static IP; SIP extension requires related SIP server/proxy provided and configured.

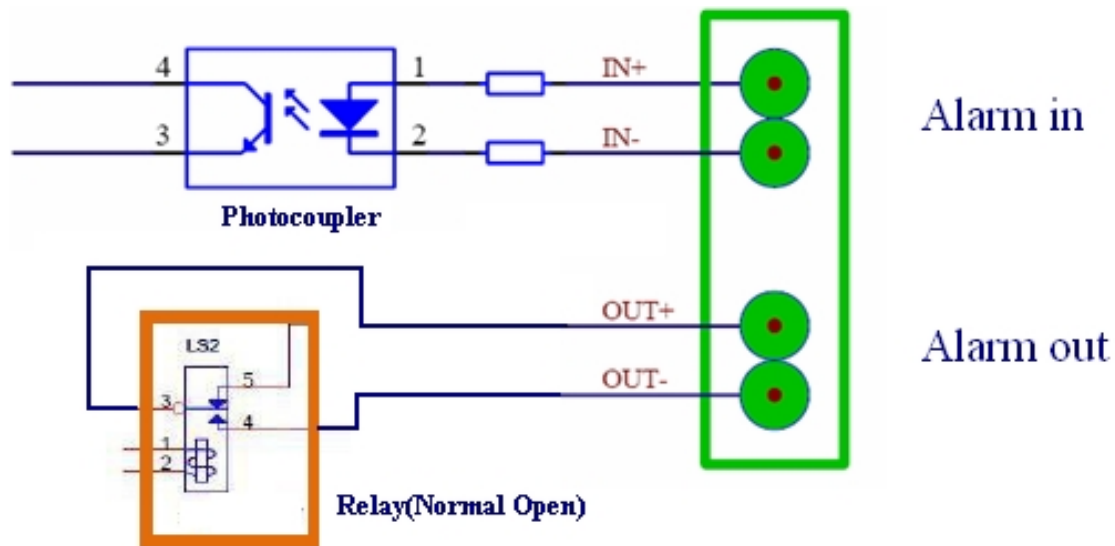

Figure 7-2: Alarm_In and Alarm_Out Connection Circuit Sample for GXV3500

NOTE:

- The Alarm_In and Alarm_Out circuit connection has to be similar to above circuit diagram and meet following requirement:

Alarm Input	Vin<15V, PINs (1.02KΩ)
Alarm Output	125VAC/0.5A, 30VDC/2A, Normal Open, PINs

- The Alarm_In circuit (like above photo coupler), if there is any voltage change smaller than 15V, as specification listed), the GXV3500 Alarm_In port will detect it and trigger the action and event.
- Higher voltage and wrong polarity connection are prohibited because this will damage the devices.

GXV3500 HOME WEB PAGE (ENCODER MODE)

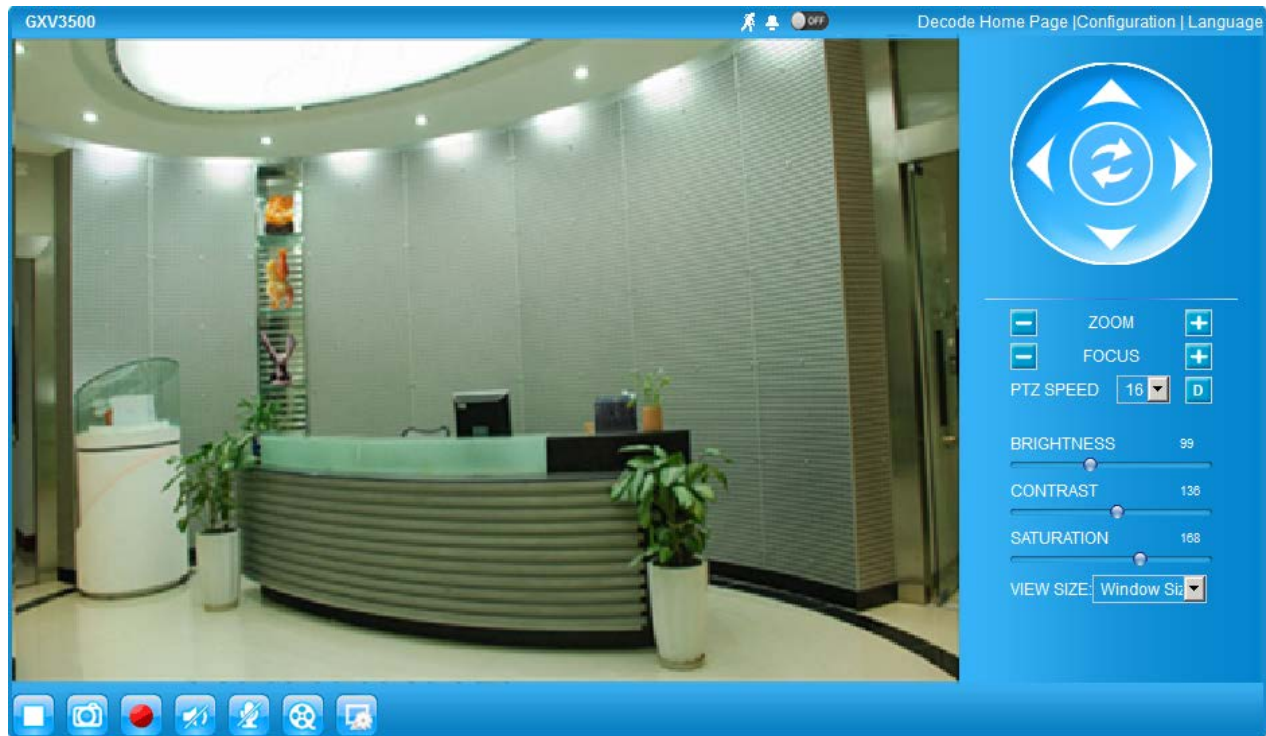

Figure 8: Home Page of GXV3500 (Encoder Mode)

- | | |
|--|---|
| <ol style="list-style-type: none"> 1. <i>View Size :</i> 2. ZOOM: 3. BRIGHTNESS bar: 4. CONTRAST bar: 5. SATURATION bar: 6. Language icon 7. Configuration icon: 8. Decode Home Page: 9. Default Video Parameter icon: 10. Stop/Play Video icon: 11. Capture (Snapshot) icon 12. Record icon: 13. Listen On/Off icon: 14. Talk On/Off icon: 15. Playback: 16. Local Configuration: 17. Motion Detection Alarm Indicator: 18. DI, Alarm_In icon: 19. DO, Alarm_Out icon: | <p>Click to switch between real resolution size and embedded window size video.</p> <p>Zoom In/Out during PTZ operation (when connected to supported camera)</p> <p>Adjust the image or video brightness.</p> <p>Adjust the image or video contrast.</p> <p>Adjust the image or video saturation.</p> <p>Click to switch webpage language.
(Current support: Chinese, English and Russian)</p> <p>Click to enter "Configuration Page" to configure the parameters of GXV3500 (Administration privilege required).</p> <p>Click to switch to Decode Mode (Reboot required to take effect).</p> <p>Click to reset video parameters (Brightness, Contrast, Saturation) to default.</p> <p>Click to Stop and Play the embedded live video.</p> <p>Click to capture and save a snapshot of current displayed video frame.
Default directory: C:\Capture, using date stamp as folder name.</p> <p>Click to Start/Stop record of current video stream into a file.
Default directory: C:\Record</p> <p>Toggle to listen/stop audio from the camera's microphone</p> <p>Toggle to talk to camera's speaker (computer microphone required)</p> <p>Click to playback the recorded video file.</p> <p>Click to configure the file path of snapshot and recorded video files.
Also adjust the video delay or smoothness.</p> <p>If (configured) motion detection alarm triggered, the indicator will flash in red.
Click the indicator icon to turn off the alarm indication.</p> <p>The indicator will be on when there is an external Alarm Input.
Click the indicator icon to turn off the alarm indication.</p> <p>Click the indicator icon manually switch the Alarm_Out operation.</p> |
|--|---|

GXV3500 Configuration & Language Page

- When click the “Configuration” icon, web page will link to configure page related parameters of the GXV3500.
- There are two big categories of settings: **Basic Settings** and **Advanced Settings**. Details will illustrate in the following Chapters.
- When click the “Language” icon, supported languages will display in Figure 2. Click to select the related webpage display language.



Figure 9: Web Language Switch

- Currently firmware only support: English (default), Simplified Chinese and Russian.

BASIC SETTINGS EXPLANATION

System Settings Page

This page allow user to configure the system settings of GXV3500.



The screenshot shows the 'GXV3500 Encode Mode Administration Interface' with a sidebar on the left containing navigation links: Home, Basic Settings, System, Video & Audio, Networking, DDNS, SIP, Status, and Advanced Settings. The main content area is titled 'Set the System Time' and includes the following settings:

- Current System Time:** 2016-05-06 16:48:58. Buttons: Sync With PC, Set Manually.
- Time Zone:** GMT-05 (New York, Toronto, Washington DC)
- Enable Daylight Saving Time**
 - Start Time:** Mar Second Sunday 2 Hour
 - End Time:** Nov First Sunday 2 Hour
- Enable NTP**
 - NTP Server:** time.nist.gov
 - NTP Update Interval(Minutes):** 1440 (5-1440)

Below these settings are three sections, each with a 'Save' button:

- OSD Date Format:** MM/DD/YYYY
- Device Name Setting:** GXV3500
- DI and DO:**
 - Digital input:** Normal Open ; Current state is Open
 - Digital output:** Normal Open ; Current state is Open
 - Alarm Output Duration:** Always

Figure 10: System Settings Page

- **Current System Time:**
 - **Sync with PC:** Display time current system is running at
Click to synchronize current time with computer.
 - **Set Manually:** Click to manually set the current time and date.
- **Time Zone:** Select from pull down menu the time zone unit located
 - **Enable DST:** Configure Day Light Saving Time
 - **NTP:** Enable and configure NTP server and update interval.

- **On Screen Display (OSD)**
 - Date Format:** Format to display the OSD date
 - **OSD Date Format:** OSD Date format, choose based on user preference.

- **Device Name Setting:** Set the name of the camera which will be shown in the result of “Search Tool” of GSurf_Pro VMS program.

- **DI and DO:** DI and DO initial status for Alarm In or Out operation.
 - **Digital Input:** State of Digital Input, normal at Open state
 - **Digital Output:** State of Digital Output, normal at Open state
 - **DO Duration:** Select operation of Alarm Output Duration from pull down list.

Video & Audio Setting Page

This page allows user to configure the video and audio related settings.

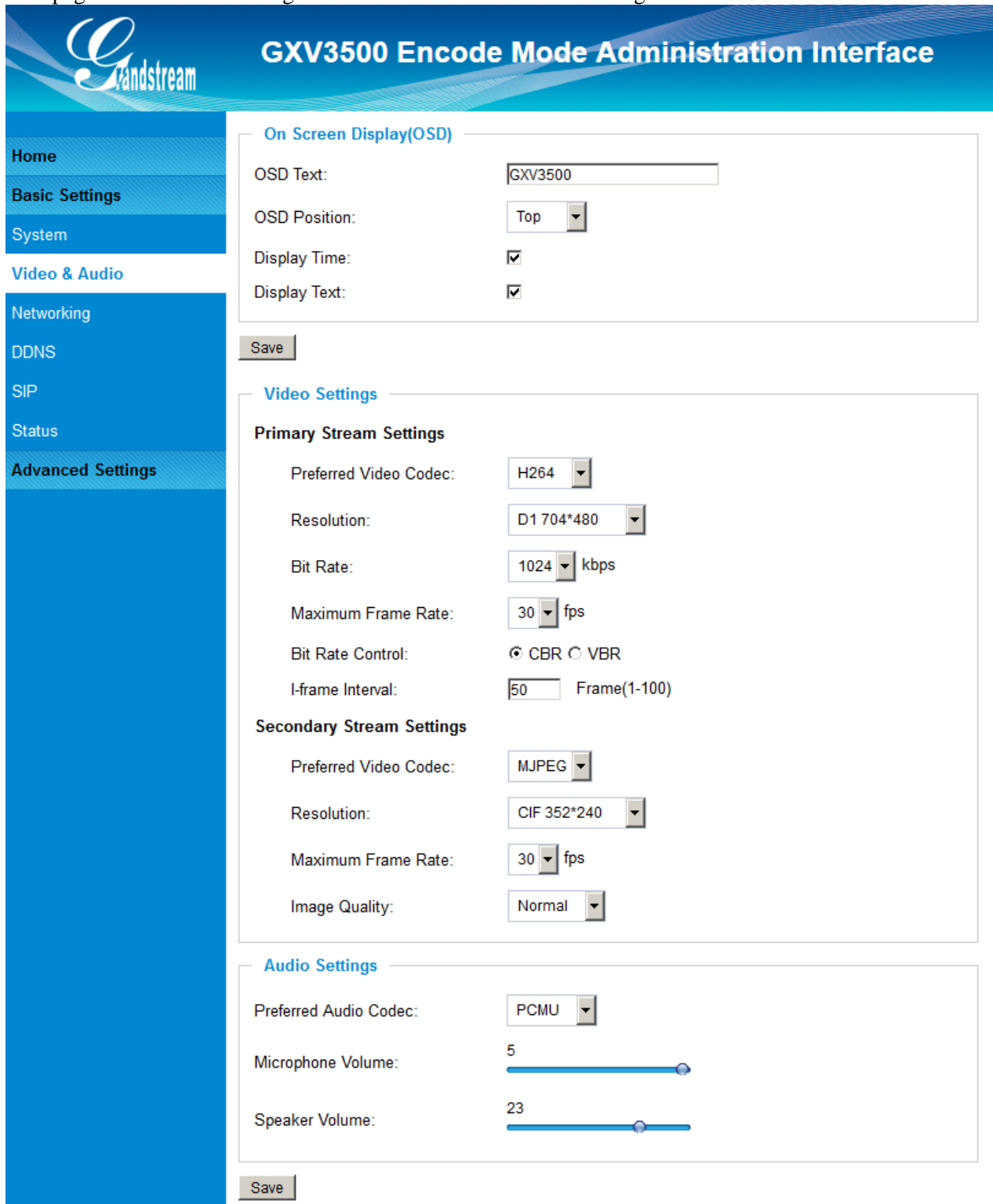

The screenshot displays the 'GXV3500 Encode Mode Administration Interface'. On the left is a navigation menu with options: Home, Basic Settings, System, Video & Audio (highlighted), Networking, DDNS, SIP, Status, and Advanced Settings. The main content area is divided into three sections:

- On Screen Display(OSD)**: Includes OSD Text (GXV3500), OSD Position (Top), Display Time (checked), and Display Text (checked). A 'Save' button is located below.
- Video Settings**:
 - Primary Stream Settings**: Preferred Video Codec (H264), Resolution (D1 704*480), Bit Rate (1024 kbps), Maximum Frame Rate (30 fps), Bit Rate Control (radio buttons for CBR and VBR, with CBR selected), and I-frame Interval (50 Frame(1-100)).
 - Secondary Stream Settings**: Preferred Video Codec (MJPEG), Resolution (CIF 352*240), Maximum Frame Rate (30 fps), and Image Quality (Normal).
- Audio Settings**: Preferred Audio Codec (PCMU), Microphone Volume (5), and Speaker Volume (23). A 'Save' button is located below.

Figure 11: Video & Audio Settings Page

On Screen Display (OSD)

- | | |
|--|---|
| <ul style="list-style-type: none"> ○ <u>OSD Text:</u> ○ <u>OSD Position:</u> ○ <u>Display Time:</u> ○ <u>Display Text:</u> | <p>Format to display the OSD date</p> <p>Input text (to identify the camera) shown on the screen.</p> <p>Show the OSD in either top or bottom position on screen.</p> <p>When checked, time will be displayed inside the video image</p> <p>When checked, inputted text will display on video image</p> |
|--|---|

Video Settings

● ***Primary Stream Settings:***

- | | |
|--|--|
| <ul style="list-style-type: none"> ○ <u>Preferred Video Codec:</u> ○ <u>Resolution:</u> ○ <u>Bit Rate:</u> ○ <u>Maximum Frame Rate:</u> ○ <u>Bit Rate Control:</u> ○ <u>Image Quality:</u> ○ <u>I-frame Interval:</u> | <p>MJPEG and H.264 supported, H.264 recommended.</p> <p>The resolution in pixels used at video image</p> <p>video bit rate or bandwidth used</p> <p>Maximum frame rate used (more data if big frame used)</p> <p>Constantly bit rate, or variable bit rate</p> <p>Image quality used when Variable Bit Rate used</p> <p>I-frame interval (suggested 2~3 times of frame rate)</p> |
|--|--|

- ***Secondary Stream Settings:*** Same as primary stream.

NOTE:

- *H.264 suggested if camera needs to be viewed via Internet.*
- *The definition of Baseline, Main Profile and High profile of H.264 please refer to:*
http://en.wikipedia.org/wiki/H.264/MPEG-4_AVC
- *If MJPEG selected, reduce max. frame rate to min. value to save bandwidth and get better image*
- Grandstream IP Camera provides two video streams, user can use them with flexibility. For example, the high-resolution stream for local recording; another low or high resolution for remote monitoring; or vice versa depending application scenarios.
- ***Use below link to calculate bandwidth and storage before installation***
<http://www.grandstream.com/support/tools/bandwidth-storage-calc>

➤ ***Audio Settings:***

- | | |
|--|---|
| <ul style="list-style-type: none"> ○ <u>Preferred Audio Codec:</u> ○ <u>Microphone Volume:</u> ○ <u>Speaker Volume:</u> | <p>PCMU, PCMA. Audio also can be disabled.</p> <p>Slide to adjust microphone gain.</p> <p>Slide to adjust the speaker volume connected.</p> |
|--|---|

Networking Setting Page

This page allows user to configure network related parameters:

IP Address Configuration

Dynamically Assigned via DHCP

Statically Configured as:

IP Address:

Subnet Mask:

Default Gateway:

DNS Configuration

Obtain DNS Server Address Automatically

Use the Following DNS Server Address:

Primary DNS Server:

Secondary DNS Server:

HTTP

HTTP Port:

Figure 12: Networking Setting Page

- **IP Address Configuration:** Camera IP address configuration
 - Dynamically Assigned via DHCP: Default setting, DHCP server assign IP to camera.
 - Statically Configured as: Static IP address configuration (Preferred for Port FWD)
- **DNS Configuration:** DNS server IP. Must be configured if using static IP.
- **HTTP:** Web access TCP port, default 80.

NOTE:

- *If camera behind SOHO router with port forwarding configuration for remote access, static IP or static DHCP has to be used to avoid IP address change after router reboot.*
- *TCP port above 5000 suggested if Port Forward HTTP for remote access, due to some ISP would block port 80 for inbound traffic. For example, change the default HTTP port from 80 to 8088, to make sure the TCP port not likely blocked.*
- *In addition to HTTP port, RTSP port is also required to configure via port forward, so remote party can view the video stream.*
- *If revise the default TCP port 80 to port “A”, then RTSP port should be “2000+A” (changed from default TCP 554). Both TCP port “A” and “2000+A” should be configured for port forwarding in the router. For example, the HTTP port changed to 8088, the RTSP port now should be 10088, both TCP ports 8088 and 10088 should be configured for port forwarding in order for remote camera access: 8088 for web portal, 10088 for video streaming.*

DDNS Settings Page

This page allows user to configure dynamic DNS related parameters:

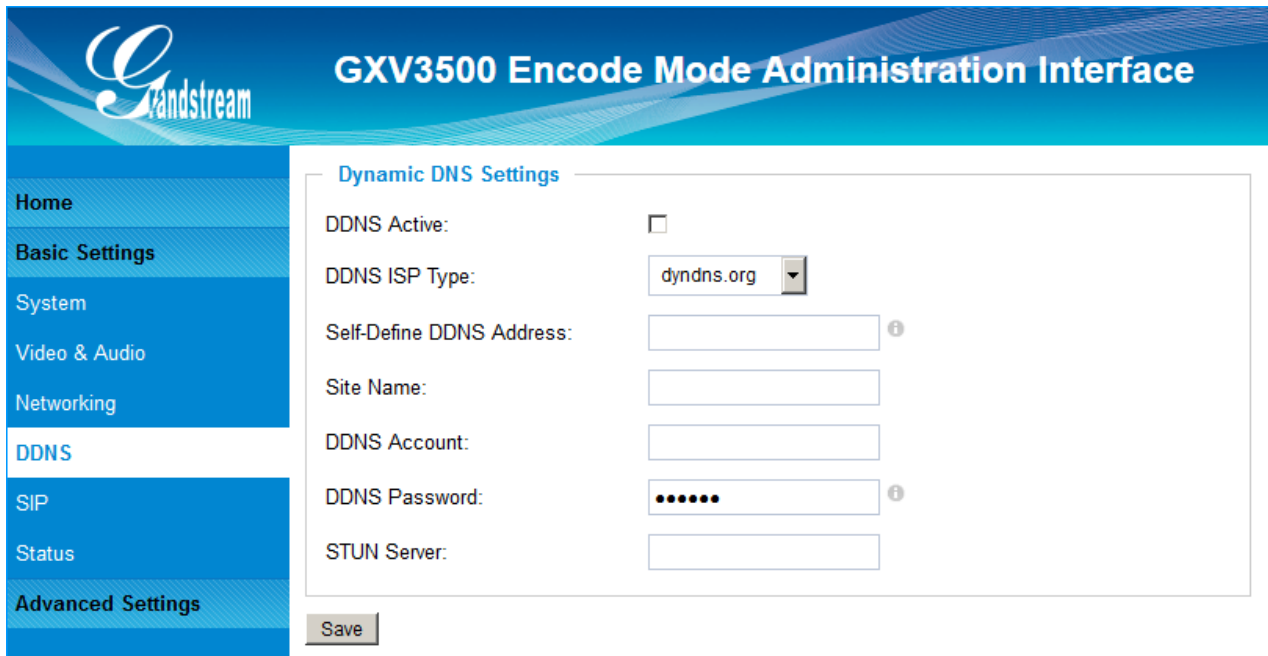
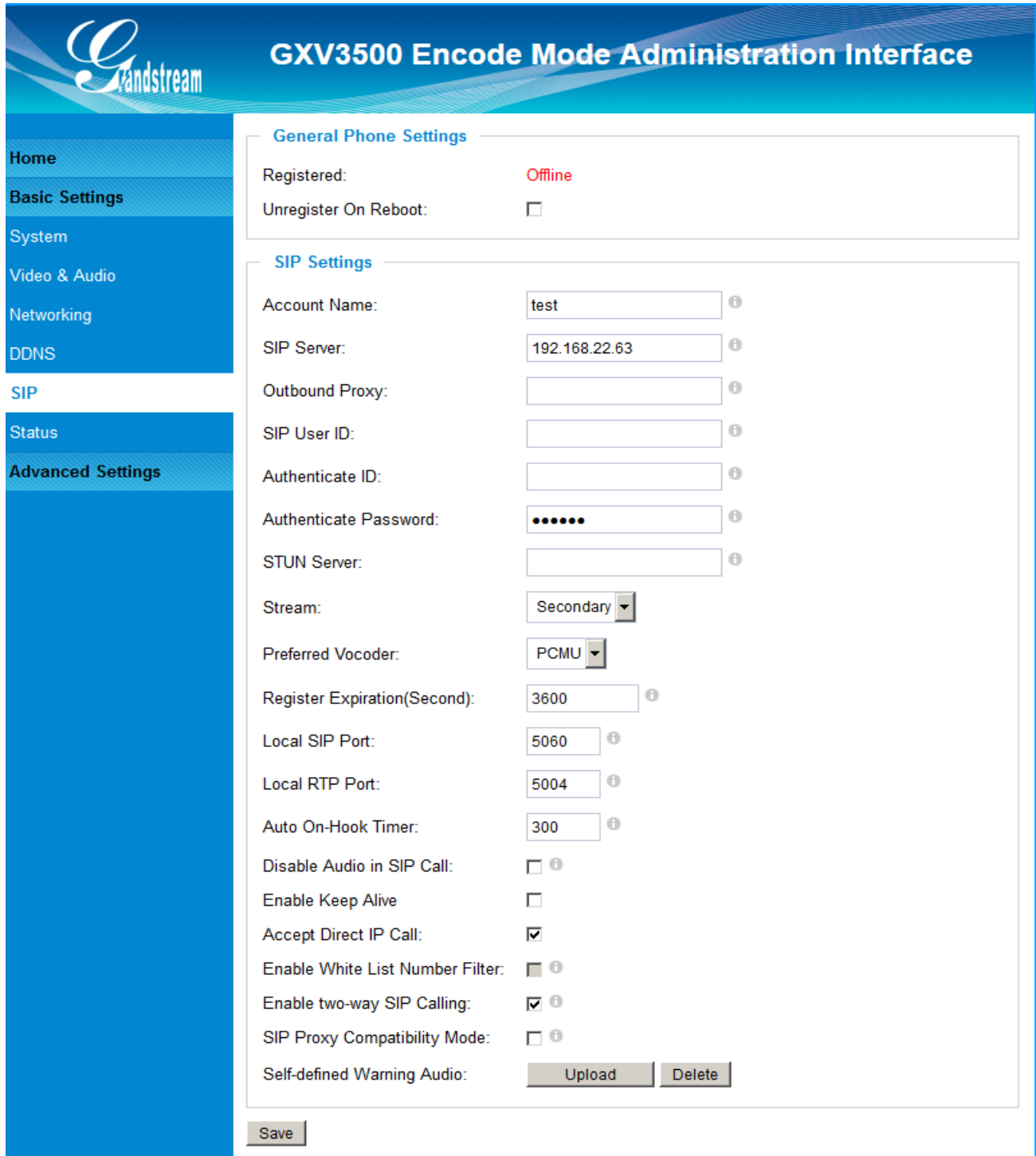

Figure 13: DDNS Setting Page

- **DDNS Active:** Enable DDNS by check this field.
- **DDNS ISP Type:** Select the DDNS service provider from the pull-down menu list
- **Self-Define DDNS Address:** Input the self-defined DDNS address
- **Site Name:** DDNS site name
- **DDNS Account:** DDNS account name
- **DDNS Password:** DDNS password
- **STUN Server:** Stun server FQDN or IP. If device behind a non-symmetric router, STUN server can help to penetrate & resolve NAT issue.

SIP Setting Page

GXV3500 can be configured as SIP endpoint to call out when alarm triggered, or allow permitted number to call in to check the audio/video if Grandstream IP videophone used.



The screenshot displays the 'GXV3500 Encode Mode Administration Interface' with a sidebar menu on the left and a main settings area on the right. The sidebar includes options like Home, Basic Settings, System, Video & Audio, Networking, DDNS, SIP, Status, and Advanced Settings. The main area is titled 'General Phone Settings' and 'SIP Settings'. Under 'General Phone Settings', the 'Registered' status is 'Offline' and 'Unregister On Reboot' is unchecked. The 'SIP Settings' section contains various fields for configuration, including Account Name, SIP Server, Outbound Proxy, SIP User ID, Authenticate ID, Authenticate Password, STUN Server, Stream, Preferred Vocoder, Register Expiration, Local SIP Port, Local RTP Port, Auto On-Hook Timer, and several checkboxes for call-related features. A 'Save' button is located at the bottom left of the settings area.

General Phone Settings	
Registered:	Offline
Unregister On Reboot:	<input type="checkbox"/>

SIP Settings	
Account Name:	test
SIP Server:	192.168.22.63
Outbound Proxy:	
SIP User ID:	
Authenticate ID:	
Authenticate Password:	•••••
STUN Server:	
Stream:	Secondary
Preferred Vocoder:	PCMU
Register Expiration(Second):	3600
Local SIP Port:	5060
Local RTP Port:	5004
Auto On-Hook Timer:	300
Disable Audio in SIP Call:	<input type="checkbox"/>
Enable Keep Alive:	<input type="checkbox"/>
Accept Direct IP Call:	<input checked="" type="checkbox"/>
Enable White List Number Filter:	<input type="checkbox"/>
Enable two-way SIP Calling:	<input checked="" type="checkbox"/>
SIP Proxy Compatibility Mode:	<input type="checkbox"/>
Self-defined Warning Audio:	Upload Delete

Save

Figure 14-1: SIP Setting Page

- **Registered:** SIP registration status. Display “Online” in Green, “Offline” in Red.
- **Unregistered on Reboot:** If checked and SIP server support, reboot camera will unbind all registered end points using this SIP account.
- **Account Name:** SIP account name used for self identification.
- **SIP Server:** FQDN or IP of SIP server from VoIP service provider
- **Outbound Proxy:** IP or FQDN of Outbound proxy server, helps penetrate NAT/Firewall
- **SIP User ID:** SIP username, or telephone number from ITSP
- **Authenticate ID:** Authenticate ID used by SIP proxy
- **Authenticate Password:** Authenticate password used by SIP proxy
- **STUN Server:** STUN server used to resolve NAT if have
- **Steam:** Which stream used for SIP call. Default 2nd stream, strongly recommended due to bandwidth and data involved at video call.
- **Preferred Vocoder:** Audio codec used for SIP call, only G.711 A or U supported.
- **Registration Expiration:** Registration expiration time, default 3600 seconds
- **Local SIP Port:** Local SIP port, default 5060
- **Local RTP Port:** Local RTP port for media, default 5004
- **Auto On-Hook Timer:** Timer (in seconds) for automatic disconnecting the SIP call. Default 300.

- **Disable Audio in SIP Call:** Disable or turn off audio of camera when SIP call established.
- **Enable Keep Alive:** Checked to help NAT resolution, sending alive packets.
- **Accept Direct IP Call:** Check to accept peer-to-peer IP call in LAN without SIP server.
- **Enable White List Number Filter:** Check to allow only white list number to call in, for security.
- **Enable two-way SIP Calling:** Check to enable two-way audio when call established (Default)
- **SIP Proxy Compatibility Mode:** Check to enable more proxy compatibility with cost of bandwidth, the SIP call will send both audio and video no matter what.
- **Self-define Warning Audio:** Upload self-defined alarm warning message audio.
(Format: G.711 .WAV format, File Size <= 300KB, Linear PCM, 8KHz Sampling Rate, 16bit, Single Channel)

SIP Open Door Settings

Enable SIP Open Door: ⓘ

Key to Open the Door: ⓘ

Delay Lock Time(Second): ▾

Phone List for Alarm Out

Phone Number	Remark Name	
<input type="text"/>	<input type="text"/>	<input type="button" value="Add..."/>
911	911	<input type="checkbox"/>
<input type="checkbox"/> Check All		<input type="button" value="Remove"/>

White List (Allowed Caller)

Phone Number	
<input type="text"/>	<input type="button" value="Add..."/>
6175669300	<input type="checkbox"/>
<input type="checkbox"/> Check All	
<input type="button" value="Remove"/>	

Figure 14-2: SIP Setting Page

SIP Open Door Setting

When selected, following settings will display at the webGUI:

- **Key to Open the Door:** DTMF password configured when call established to open door ,
- **Delay Lock Time:** Timer (in seconds) for relay/lock to recover. (default 1 second)
- **Phone List for Alarm Out:** Callee or receiver’s number when alarm call trigged.
- **White List (Allowed Caller):** Phone numbers allowed calling into the camera.

NOTE:

- *When selected, this feature will override any existing Alarm Out (like Alarm In triggered Alarm Out, or Motion Detection triggered Alarm Out).*
- *The Alarm Out Port has to connect to Electric Door Strike or Relay to control door open/close.*
- *Remote SIP phone needs key in password (**digits 0-9 only, ended with # key**) matching the configuration here to open the door. (via DTMF)*

Status Page

This page shows the GXV3500 operation status:

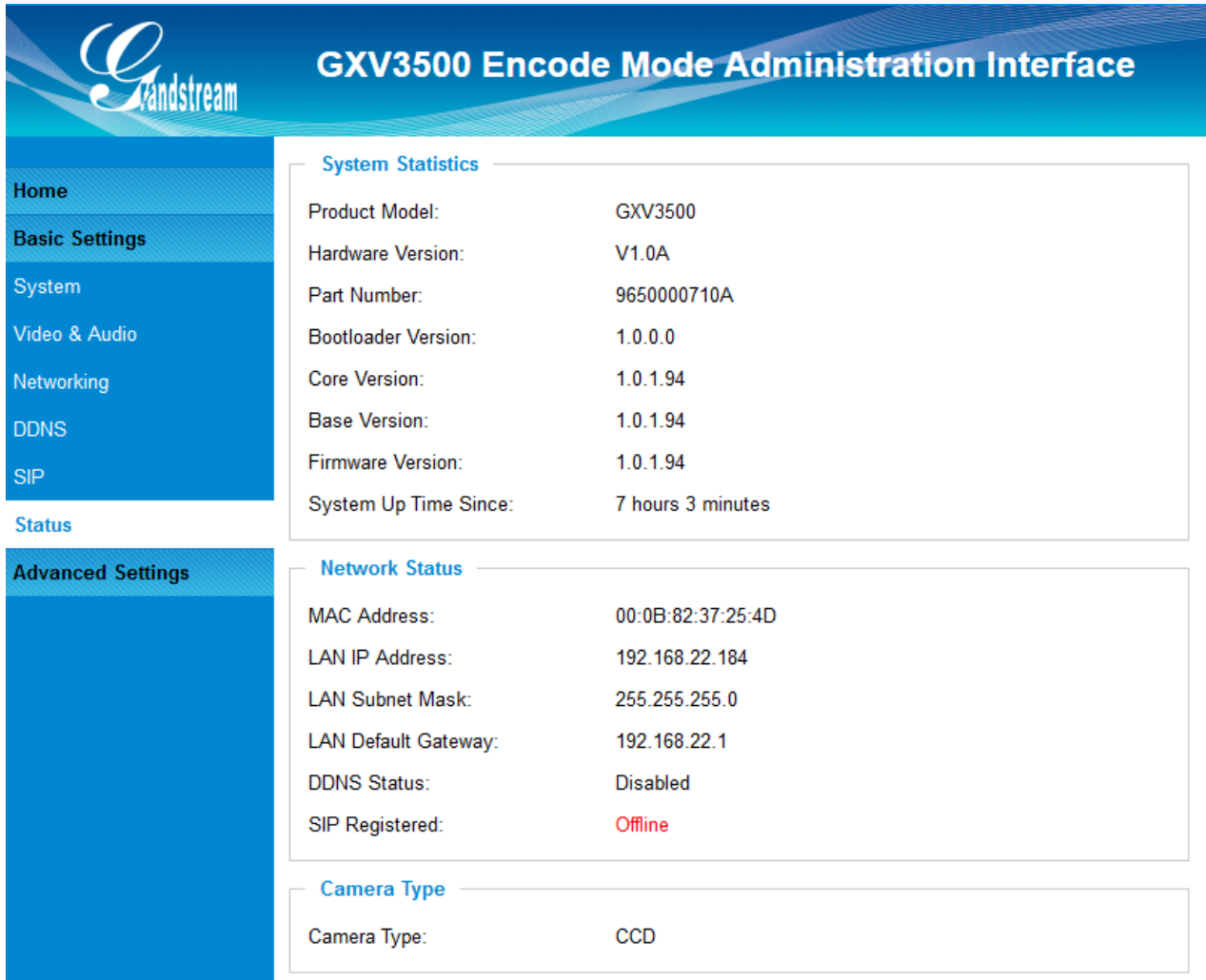

Grandstream **GXV3500 Encode Mode Administration Interface**

- Home
- Basic Settings
- System
- Video & Audio
- Networking
- DDNS
- SIP
- Status
- Advanced Settings

System Statistics

Product Model:	GXV3500
Hardware Version:	V1.0A
Part Number:	9650000710A
Bootloader Version:	1.0.0.0
Core Version:	1.0.1.94
Base Version:	1.0.1.94
Firmware Version:	1.0.1.94
System Up Time Since:	7 hours 3 minutes

Network Status

MAC Address:	00:0B:82:37:25:4D
LAN IP Address:	192.168.22.184
LAN Subnet Mask:	255.255.255.0
LAN Default Gateway:	192.168.22.1
DDNS Status:	Disabled
SIP Registered:	Offline

Camera Type

Camera Type:	CCD
--------------	-----

Figure 15: Status Page

NOTE:

- When SIP account registered, the status will display “Online” in Green.
- When SIP account unregistered, the status will display “Offline” in Red, as below.

SIP Registered: Offline

ADVANCED SETTINGS EXPLANATION

User Management Page

This page allows user to do user management:

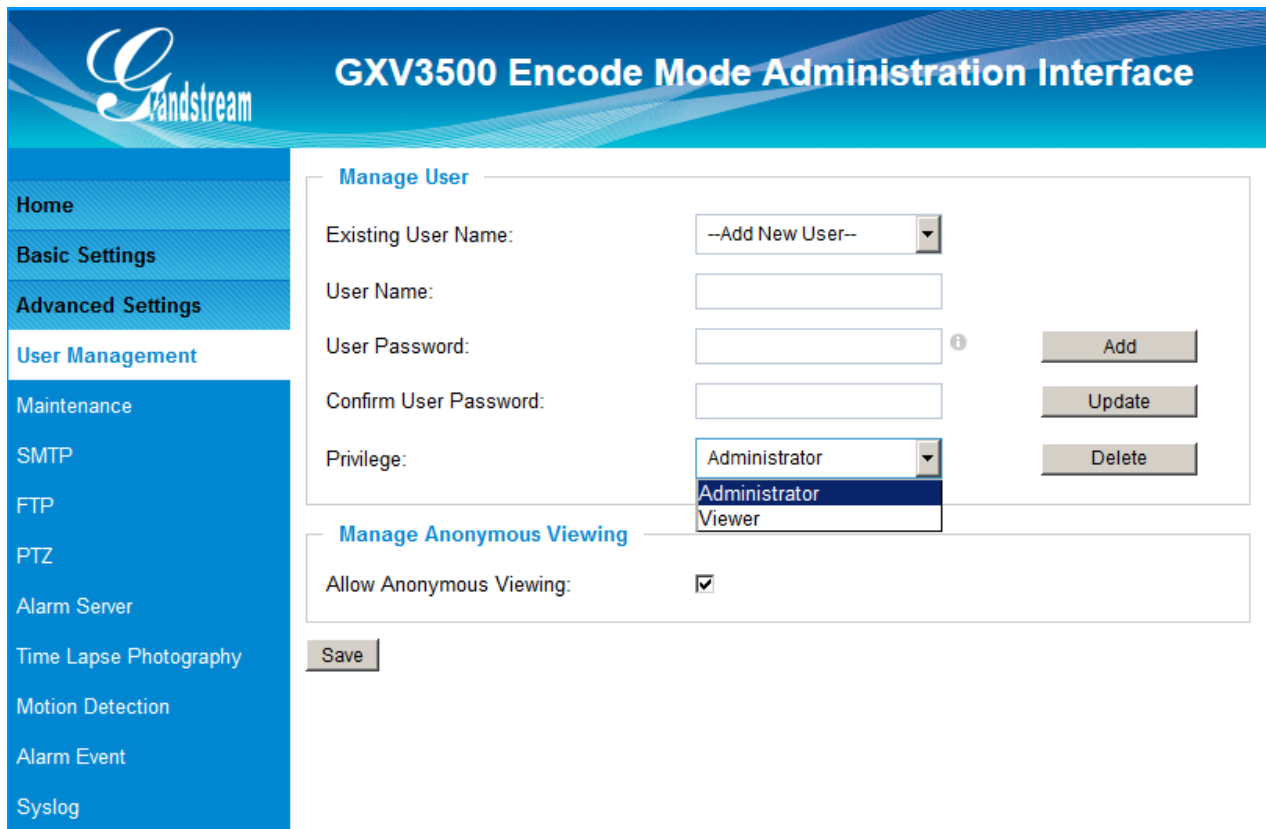

Figure 16: User Management Page

- **Existing User Name:** Allow revise existing user or add new user
- **User Name:** The name of users need to be revised
- **User Password:** New password if revise password
- **Confirm User Password:** Re-enter the new password for verification, must match.
- **Privilege:** Choose user privilege. Two levers: Administrator, Viewer. Viewer cannot change any settings.

Manager Anonymous Viewing

- **Allow Anonymous Viewing:** When checked, no security enhanced. Any person can view the camera if knowing the IP or FQDN of the camera, but cannot change anything, just view ONLY.

Maintenance Page

This page allows user to maintain the camera:

Restart the Device

Restart the Device.

Restart

Restore the Device

Reset Settings, except IP Address, to Factory Default.

Restore

Firmware Upgrade and Provisioning

Upgrade via: HTTP

Firmware Server Path: firmware.grandstream.com

Config Server Path: config.grandstream.com

XML Config File Password:

Automatic Upgrade Interval(Minutes): 10080

Automatic Upgrade:

Save

System Access

Disable Telnet:

Enable UPnP Discovery:

Save

Figure 17: Maintenance Page

- **Restart:** When clicked, the camera will reboot or restart (soft reboot).
- **Restore:** When clicked, the camera will be reset to factory default, wiping out all the configurations (except IP address)
- **Upgrade via:** Upgrade firmware via TFTP, HTTP or HTTPS
- **Firmware Server Path:** Server path holding the firmware
- **Config Server Path:** Server path holding the configuration file (auto provisioning)
- **XML Config File Password:** Password for encrypt the XML based configuration file
- **Automatic Upgrade Interval (Minutes):** Time interval for automatic upgrade, default 10080
- **Automatic Upgrade:** Checked to enable automatic firmware upgrade and provisioning.

System Access

- **Disable Telnet:** Check to disable Telnet to enhance security.
- **Enable UPnP Discovery:** Used for UPnP automatic discovery of the device in related network environment. Default enabled.

NOTE:

- *Only XML based automatic provisioning is supported by GXV3500.*

SMTP Setting Page (Email Alarm)

This page allows user to configure email client to send out email when alarm triggered:

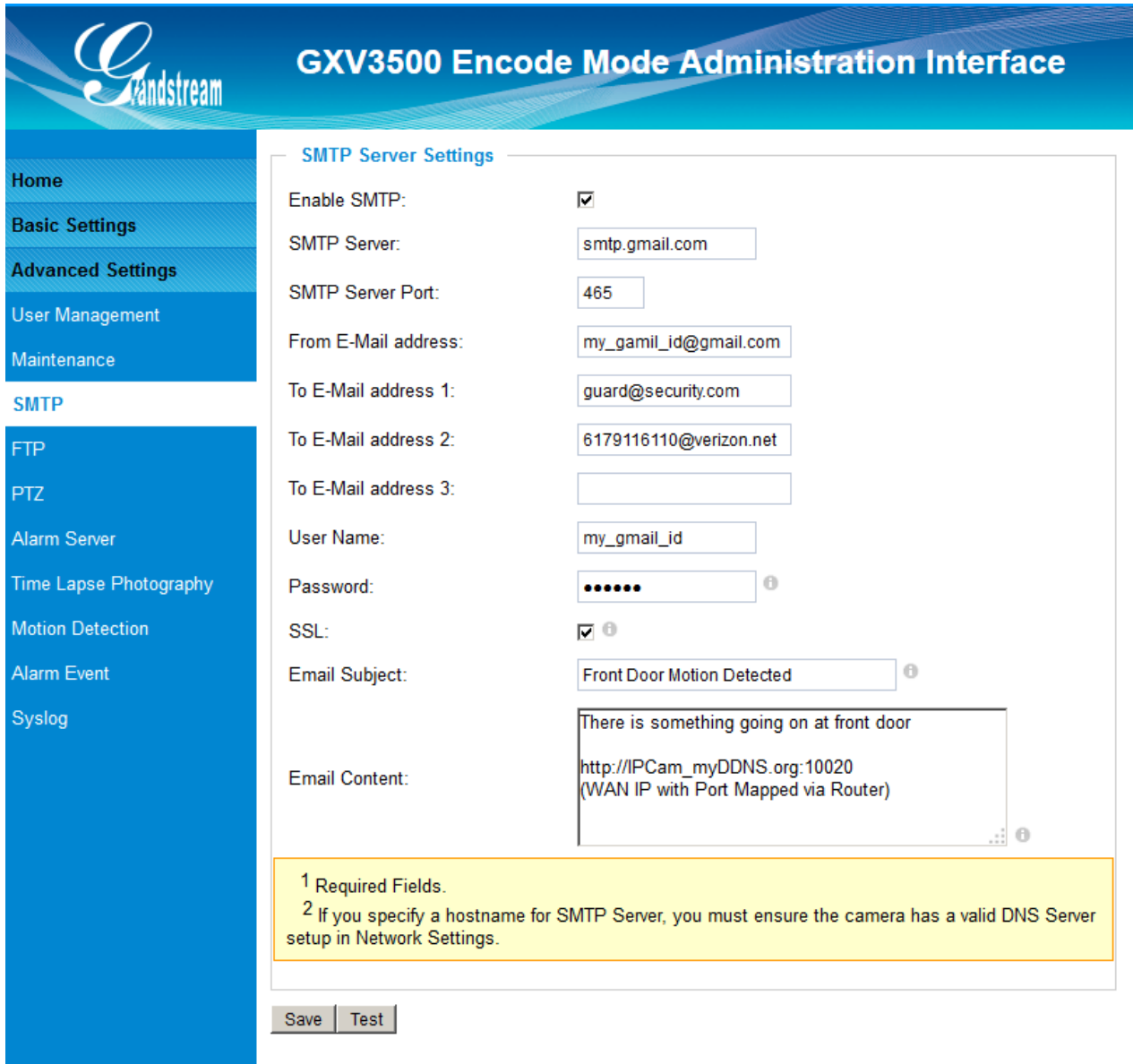

Grandstream GXV3500 Encode Mode Administration Interface

SMTP Server Settings

Enable SMTP:

SMTP Server:

SMTP Server Port:

From E-Mail address:

To E-Mail address 1:

To E-Mail address 2:

To E-Mail address 3:

User Name:

Password: ⓘ

SSL: ⓘ

Email Subject: ⓘ

Email Content:

There is something going on at front door
 http://IPCam_myDDNS.org:10020
 (WAN IP with Port Mapped via Router)

 ⓘ

1 Required Fields.
2 If you specify a hostname for SMTP Server, you must ensure the camera has a valid DNS Server setup in Network Settings.

Figure 18-1: SMTP Setting Page

- **Enable SMTP:** When checked will enable email client.
- **SMTP Server:** SMTP Email Server IP or Domain Name
- **SMTP Server Port:** Port number used by server to send email
- **From Email address:** The email address of alarm email sending from, usually client email ID
- **To E-Mail address:** The email address to receive the alarmed email, total 3 can be configured.
- **User Name:** Email client User ID
- **Password:** Email client password
- **SSL:** Check if the SMTP email server requires SSL

- **Email Subject:** Customizable email subject for user's convenience
- **Email Content:** Customizable email content for user's purpose.

NOTE:

- Click "Save" to save the email configuration information.
- Click "Test" after configuration, if setting is correct, a test email will send out and "Test successful!" orange bar will display like below

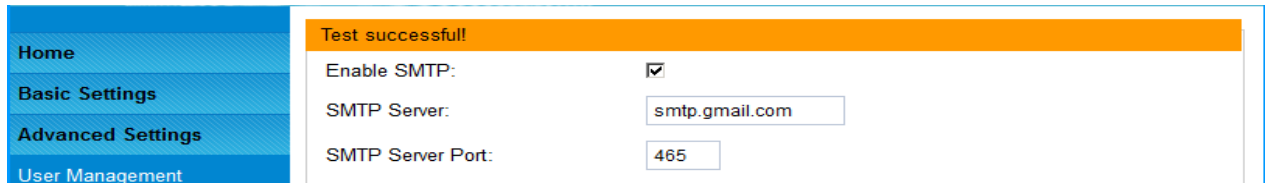

The screenshot shows a web interface for SMTP settings. On the left is a blue navigation menu with options: Home, Basic Settings, Advanced Settings, and User Management. The main content area has a blue header with the text "Test successful!". Below this, there are three configuration items: "Enable SMTP:" with a checked checkbox, "SMTP Server:" with a text input field containing "smtp.gmail.com", and "SMTP Server Port:" with a text input field containing "465".

Figure 18-2: SMTP Setting Page

FTP Settings Page (Upload Alarm)

This page allows user to configure FTP parameters to upload the alarm or video recording:

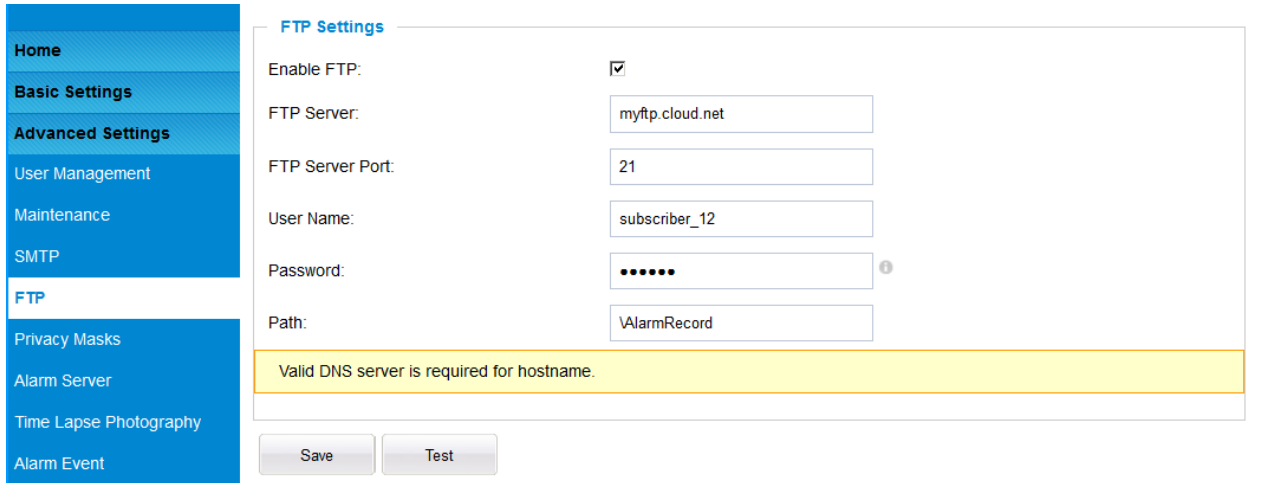

Figure 19: FTP Setting Page

- **Enable FTP:** When checked will enable built-in FTP client.
- **FTP Server:** IP or Domain name of FTP site or server
- **FTP Server Port:** TCP port for FTP server, default port number 21
- **User Name:** FTP server User ID
- **Password:** FTP server user password
- **Path:** Path in the server where upload files are stored or saved.

NOTE:

- Click “Save” to save the FTP configuration information.
- Click “Test” after configuration, if setting is correct, a test FTP operation will be performed and “Test successful!” orange bar will display if the operation is successful, like below:

Test successful!

PTZ

This page allows user to configure PTZ parameters if the connected analogue camera support Pelco-D or Pelco-P protocol.

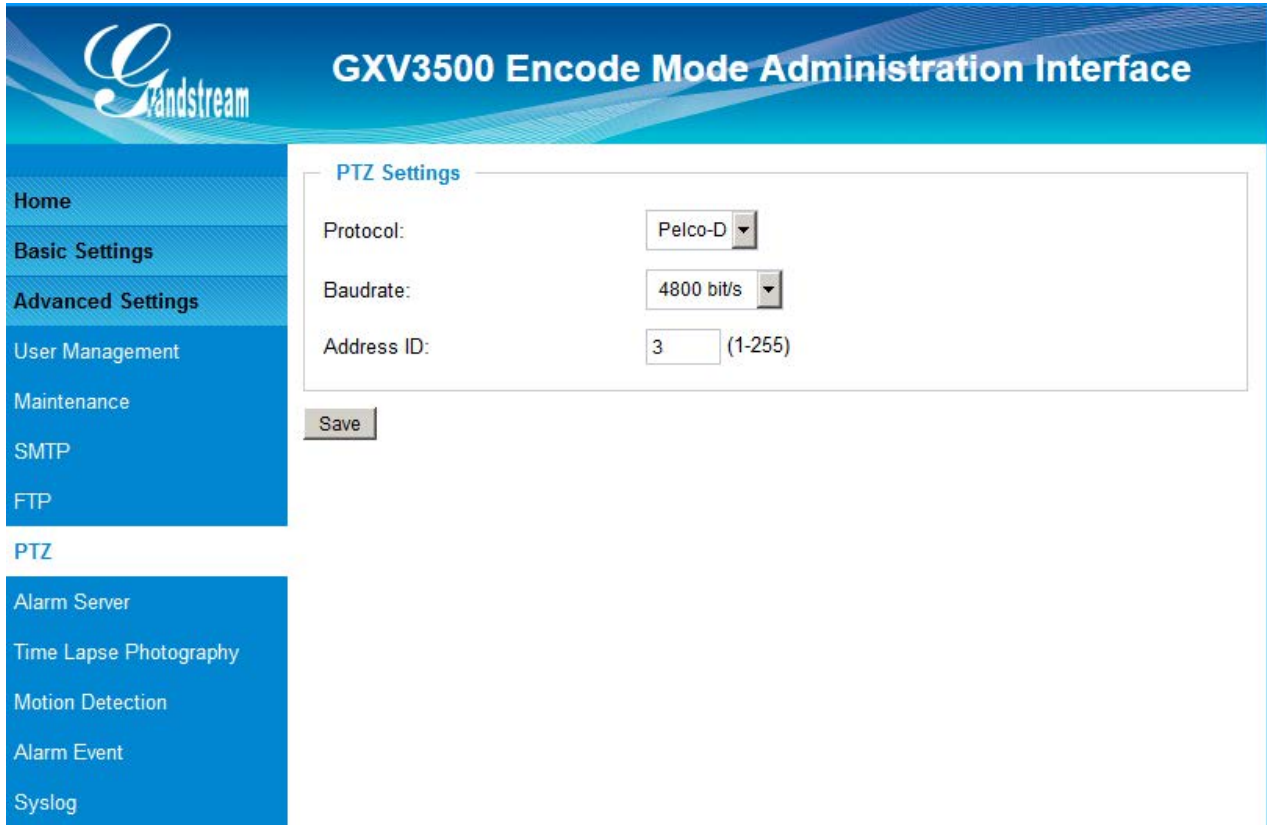

Grandstream GXV3500 Encode Mode Administration Interface

PTZ Settings

Protocol:

Baudrate:

Address ID: (1-255)

Figure 20: PTZ Setting Page

- **Protocol:** Pull-down to select supported PTZ protocol by connected analogue camera. Only Pelco-D or Pelco-P allowed.
- **Baudrate:** The baudrate used by the analogue camera interface, select from the pull-down menu.
- **Address ID:** Hardware Pelco-D or Pelco-P address ID used by the analogue camera, please refer to related camera user manual for this ID (or PIN switch in the UM), then fill in related matching address into this field.

NOTE:

- *The address ID filled here has to be same and match the one used in the connected analogue camera. Otherwise the PTZ will not function or behave abnormal due to the wrong Pelco-D or Pelco-P address used.*

Alarm Server Setting Page

This page allows user to configure alarm HTTP server to upload alarms (Upload Alarms to VMS platform supported or HTTP Server for processing)

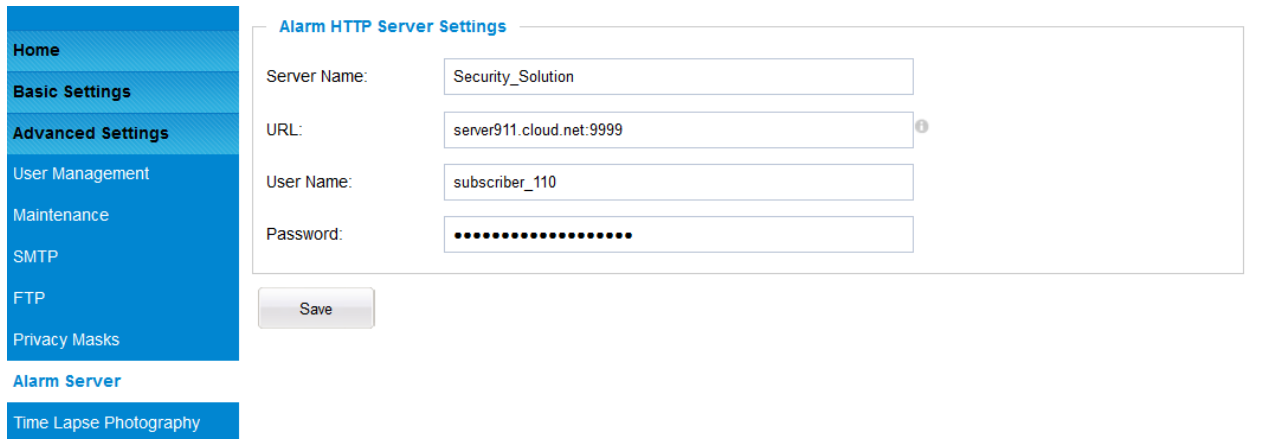

Figure 21: Alarm HTTP Server Setting Page

- **Server Name:** The name of HTTP server or VMS system
- **URL:** URL of the Server
- **User Name:** User ID from that Server
- **Password:** Password for that User ID

NOTE:

- *Grandstream provide HTTP API to help third party companies by using HTTP server or VMS to develop further solutions for their customers.*
http://www.grandstream.com/products/surveillance/general/documents/grandstream_http_api.pdf
- *Grandstream IP Camera and Encoder (include GXV3500) are ONVIF certified.*

Time Lapse Photography

This page allows user to configure Time Lapse Photography (or period snapshot).

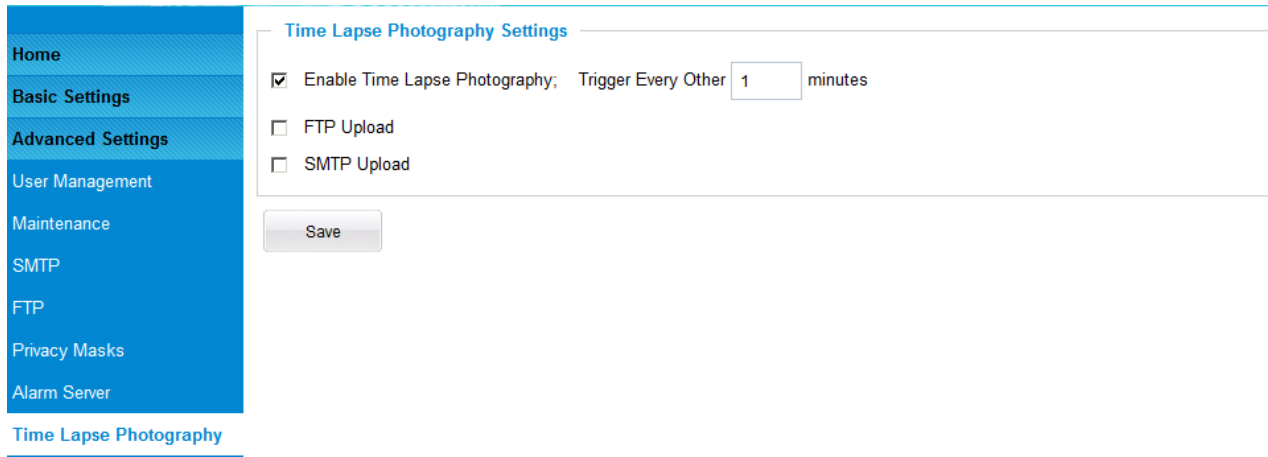

Figure 22: Time Lapse Photography Configuration Page

- ***Enable Time Lapse Photography:***
Check to enable this feature. User can configure the timer or duration of the triggering moment, minimum value is 1 minute.
- ***FTP Upload:***
Enabled will allow device to upload the snapshots to FTP server. The FTP server is configured at “FTP” server page illustrate before.
- ***SMTP Upload:***
Enabled will allow device to email the snapshots via email server. The email server is configured at “SMTP” configuration page.

Click “Save” button to save the changes made and the feature will take effect immediately.

Motion Detection

This page allows user to configure motion detection to trigger alarms:

Home

Basic Settings

Advanced Settings

User Management

Maintenance

SMTP

FTP

PTZ

Alarm Server

Time Lapse Photography

Motion Detection

Alarm Event

Syslog

Motion Detection Settings

Motion detection will be disabled if both primary and secondary codec are set to MJPEG

Show Regions

Enable Motion Detection ✎ ✕

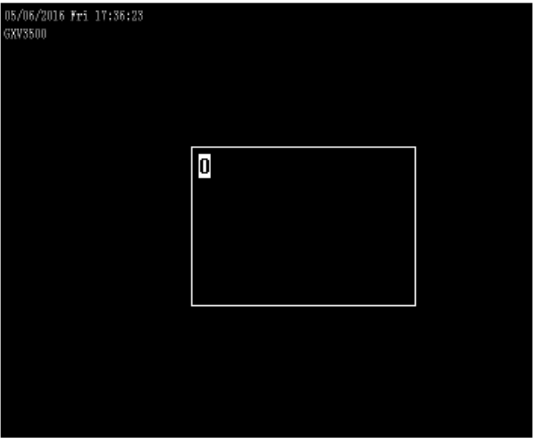

Region ID	Sensitivity
0	50
1	50
2	50
3	50
4	50
5	50
6	50
7	50
8	50
9	50
10	50
11	50
12	50
13	50
14	50
15	50

Alarm Action

Record Video From Pre Alarm Up to seconds to After Alarm Up to seconds [?]

Voice Alarm to SIP Phone

Alarm Output

Upload to Alarm Center

Upload to Alarm HTTP Server

Email and FTP upload JPEG and Store it to SD driver

Pre Alarm Up to seconds to After Alarm Up to seconds

Motion Detection Time Schedule

Region ID	Date	Start Time	End Time	
<input type="text" value="0"/>	Everyday	00:00	23:59	<input type="button" value="Add"/>
0	Everyday	00:00	23:59	<input type="checkbox"/>

Check All

Figure 23-1: Motion Detection Configuration Page

- **Show Regions:** When checked, Motion Detection region with number will be displayed as a white rectangle in the screen. When “Edit” clicked, the Rectangle will become **Red**, as shown in Figure 16-1.
- **Enable Motion Detection:** When checked, Motion Detection is enabled.

There are total 16 regions be available for MD configuration, from region 0 to 15. Select and highlight the number of region to configure the MD and the sensitivity.

Alarm Action:

- **Record Video From Pre Alarm Up to XXX seconds to After Alarm Up to XXX seconds:** This setting to allow configure pre/post alarm video for applications to utilize. MJPEG is NOT supported for this feature.
- **Voice Alarm to SIP Phone:** If a SIP server or peer IP device configured, check this will allow MD event to trigger alarm SIP call to pre-configured number.
- **Alarm Output:** Select will allow MD to send alarm to Alarm Output interface.
- **Upload to Alarm Center:** When checked, the alarm video will be transferred to Alarm Center, like Grandstream free GSurf_Pro VMS software, or other 3rd party Alarm Center.
- **Upload to Alarm HTTP Server:** When checked MD alarm will be send to 3rd party HTTP server via programmed Grandstream HTTP API.
- **Email and FTP upload JPEG and Store it to SD driver:** When checked, snapshots of trigger moment will be emailed to pre-configured email account and also uploaded to FTP server if configured, will also be stored to the microSD card inserted. The pre/post alarm snapshot numbers can be configured based on time (in second) to meet user’s requirement.

Motion Detection Time Schedule:

Click the “ + ” will expand the following interface to allow user to configure the Time Schedule for related Motion Detection region to take action.

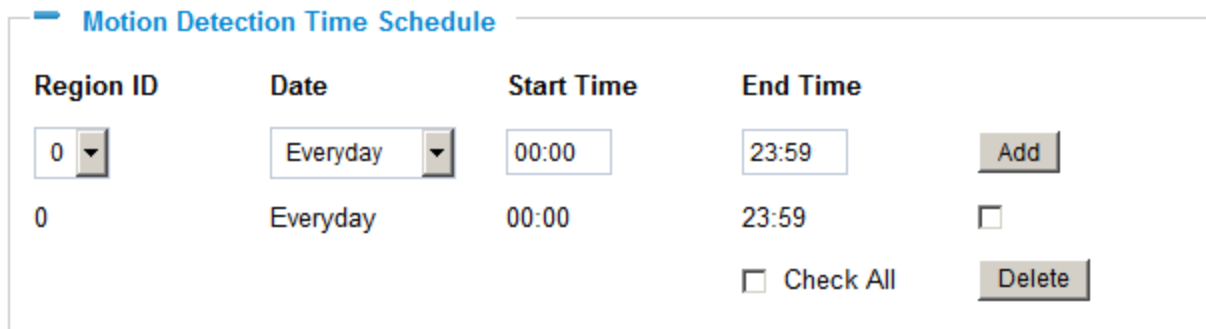

Region ID	Date	Start Time	End Time	
0	Everyday	00:00	23:59	Add
0	Everyday	00:00	23:59	<input type="checkbox"/>
				<input type="checkbox"/> Check All
				Delete

Figure 23-2: Motion Detection Schedule Configuration Page

- *As shown in Figure 23-2, user can configure the Motion Detection Region with related Start and Stop time to control the motion detection operation.*

NOTE:

- User has to configure the “Time Schedule”; otherwise the Motion Detection Alarm will not work if there is no time schedule configured.
- *Grandstream free GSurf_Pro V2 VMS software can be downloaded from:*
http://www.grandstream.com/sites/default/files/Resources/GSurf_Pro_V2_1.0.3.13.zip

Alarm Event

This page allows user to configure the Alarm_In event and related actions.

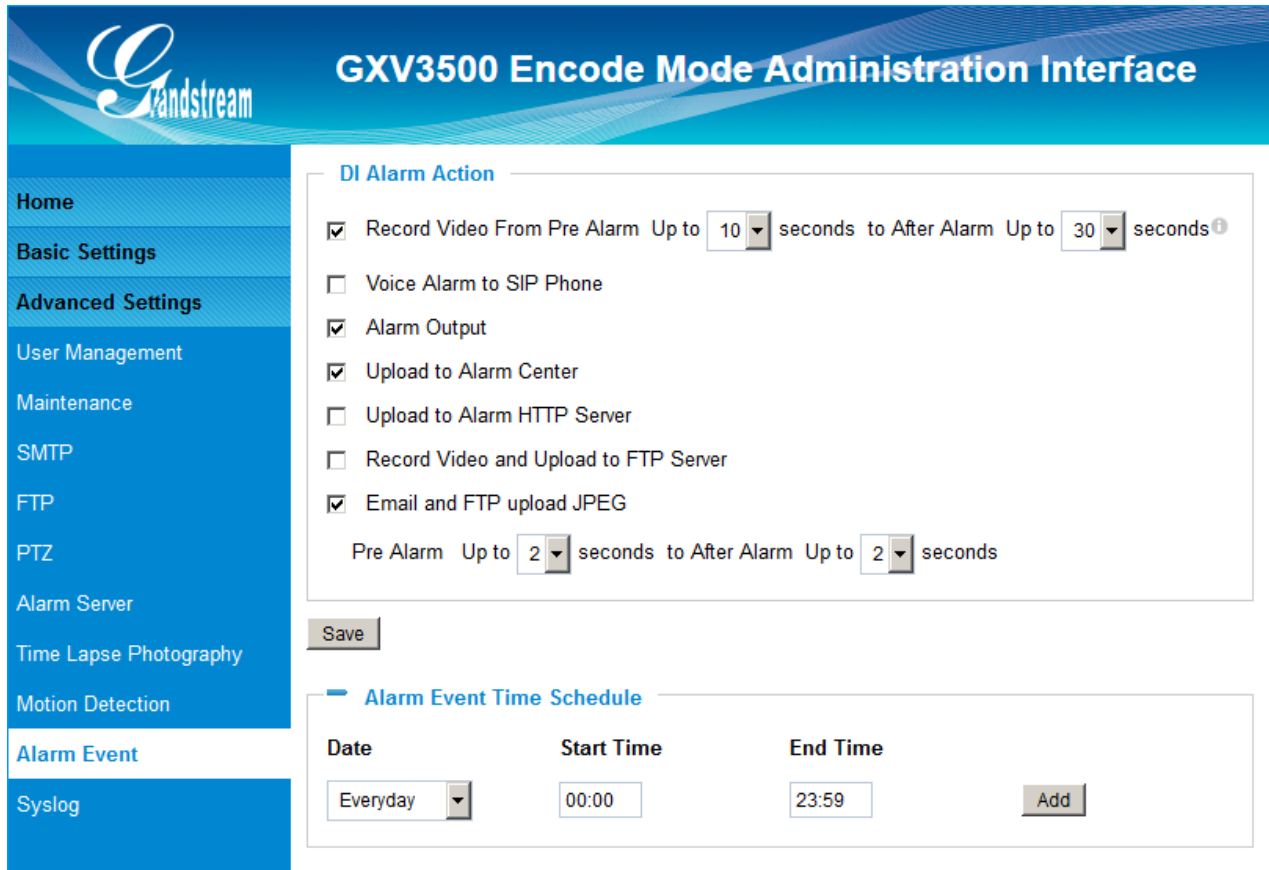

DI Alarm Action

- Record Video From Pre Alarm Up to 10 seconds to After Alarm Up to 30 seconds ⓘ
- Voice Alarm to SIP Phone
- Alarm Output
- Upload to Alarm Center
- Upload to Alarm HTTP Server
- Record Video and Upload to FTP Server
- Email and FTP upload JPEG

Pre Alarm Up to 2 seconds to After Alarm Up to 2 seconds

Alarm Event Time Schedule

Date	Start Time	End Time	
Everyday	00:00	23:59	<input type="button" value="Add"/>

Figure 24-1: Alarm_In Action Configuration Page

DI Alarm Action Setting:

- **Pre/Post Alarm Recording (Record Video From Pre Alarm Up to XXX to After Up to XXX):**
Depending on 1st stream resolution, this allows internal buffer to store the pre/post alarm video for applications to utilize.
- **Voice Alarm to SIP Phone:**
Enabled will allow device to make SIP call after receiving Alarm_In. See below NOTE for example.
- **Alarm Output:**
Enabled will allow Alarm Output after receiving Alarm_In signal.
- **Upload to Alarm Center:** Upload to alarm center like 3rd party VMS system.
- **Upload to Alarm HTTP Server:**
Upload to 3rd party HTTP server or application using HTTP API.
- **Record Video and Upload to FTP Server:**
Upload video recording to pre-configured FTP server.

➤ **Email and FTP upload JPEG and Store it to SD drive:**

Email, FTP and Store to the SD card the configurable trigger moment JPEG snapshots.

Click “Save” to save the settings. Following bar will display if operation successful.



NOTE:

- **Voice Alarm to SIP Phone:** Application example: Intercom System, press button as Alarm_In, the pre-programmed SIP number or peer IP device will be called. If the receiver is Grandstream Video phone, the callee can use DTMF PIN code to operate and Open Door.
- **MJPEG is NOT supported for this feature.**

Alarm Event Time Schedule:

Click the “Alarm Event Time Schedule” will bring up following interface to allow user to configure the Time Schedule for the Alarm_In to take action.

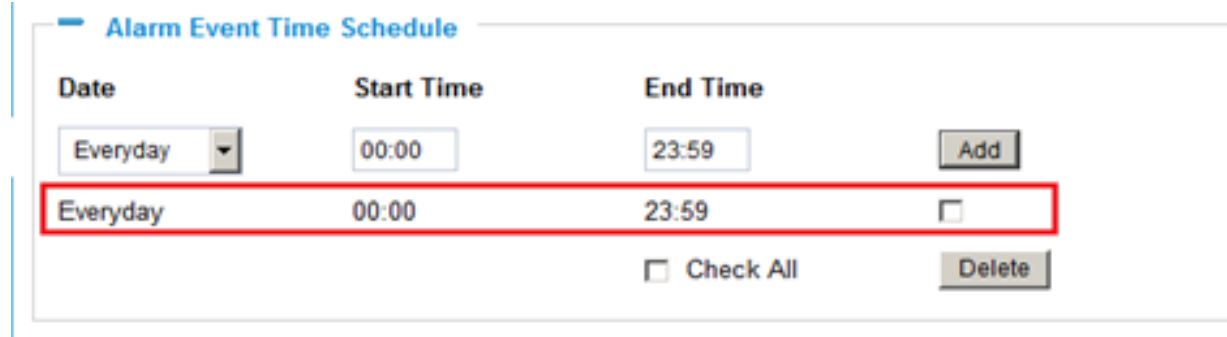

Figure 24-2: Alarm Event Time Schedule Configuration Page

NOTE:

- User has to configure the “Alarm Event Time Schedule”; otherwise the Alarm In interface will not work if there is no time schedule configured.

Syslog Settings

This page allows user to enable the Syslog to help troubleshooting problems.

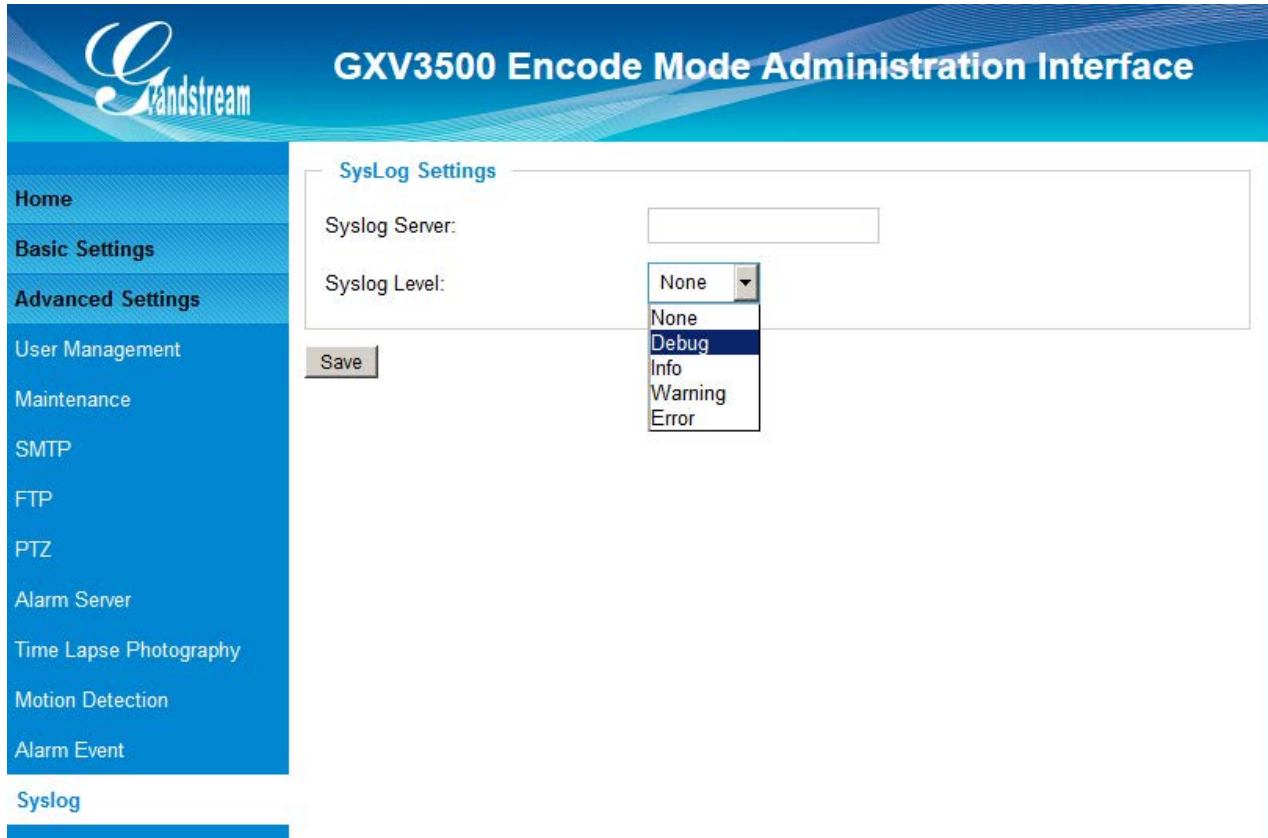

Figure 25: Syslog Setting Page

- **Syslog Server:** Syslog server IP or Domain Name
- **Syslog Level:** Lever of syslog message sent to the syslog server:
None, Debug, Info, Warning, Error.

SOFTWARE UPGRADE

This page allows user to configure firmware upgrade:

Software upgrade can be done via TFTP, HTTP or HTTPS. The corresponding configuration settings are in the ADVANCED SETTINGS configuration page.

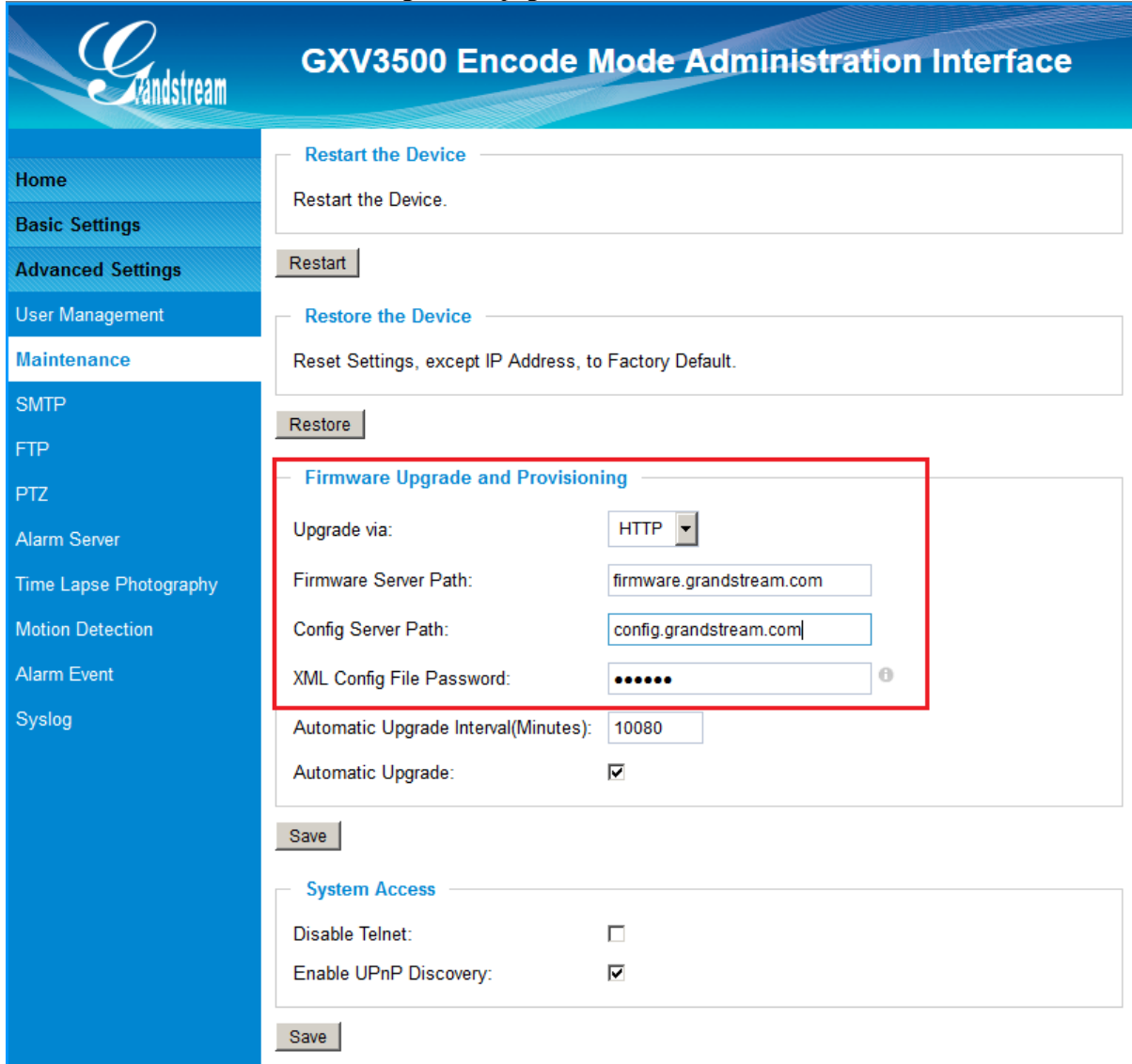

The screenshot displays the 'GXV350 Encode Mode Administration Interface'. On the left is a navigation menu with options: Home, Basic Settings, Advanced Settings, User Management, Maintenance, SMTP, FTP, PTZ, Alarm Server, Time Lapse Photography, Motion Detection, Alarm Event, and Syslog. The 'Maintenance' section is active, showing three sub-sections: 'Restart the Device', 'Restore the Device', and 'Firmware Upgrade and Provisioning'. The 'Firmware Upgrade and Provisioning' section is highlighted with a red box and contains the following fields:

- Upgrade via: HTTP (dropdown menu)
- Firmware Server Path: firmware.grandstream.com
- Config Server Path: config.grandstream.com
- XML Config File Password: [masked]
- Automatic Upgrade Interval(Minutes): 10080
- Automatic Upgrade:

Below this section is a 'Save' button. The 'System Access' section below it includes:

- Disable Telnet:
- Enable UPnP Discovery:

A 'Save' button is also present at the bottom of the System Access section.

Figure 26: Firmware Upgrade and Provisioning

NOTE:

- *Grandstream recommends end-user use the Grandstream HTTP server: **firmware.grandstream.com***
- *For large companies, we recommend to maintain their own TFTP/HTTP/HTTPS server for upgrade and provisioning procedures.*

Instructions for local firmware upgrade using TFTP server:

1. Unzip the file and put all of them under the root directory of the TFTP server.
2. Load the TFTP server from the PC and make sure the device in the same LAN segment.
3. Please go to File -> Configure -> Security to change the TFTP server's default setting from "Receive Only" to "Transmit Only" for the firmware upgrade.
4. Start the TFTP server.
5. In webGUI of IP camera, configure the Firmware Server Path with the IP address of the PC.
6. Update the change and reboot the unit

End users can also choose to download the free HTTP server from <http://httpd.apache.org/> or use Microsoft IIS web server.

Configuration File Download

Grandstream SIP Device can be configured via Web Interface as well as via Configuration File through TFTP or HTTP/HTTPS. "Config Server Path" is the TFTP or HTTP/HTTPS server path for configuration file. It needs to be set to a valid URL, either in FQDN or IP address format. The "Config Server Path" can be same or different from the "Firmware Server Path".

A configuration parameter is associated with each particular field in the web configuration page. A parameter consists of a Capital letter P and 1 to 3 (Could be extended to 4 in the future) digit numeric numbers. i.e., P2 is associated with "Admin Password" in the ADVANCED SETTINGS page. For a detailed parameter list, please refer to the corresponding firmware release configuration template.

When Grandstream Device boots up or reboots, it will issue request for configuration file named "cfgxxxxxxxxxxxx.xml", where "xxxxxxxxxxxx" is the MAC address of the device, i.e., "cfg000b820102ab.xml". The configuration file name should be in lower cases.

NOTE:

- *GXV3500 only support XML automatic provisioning.*
- *Grandstream recommends end-user use the Grandstream HTTP server:*

RESTORE FACTORY DEFAULT SETTING

WARNING!

Restoring the Factory Default Setting will DELETE all configuration information of the camera. Please BACKUP or PRINT out all the settings before approach to following steps. Grandstream will not take any responsibility if you lose all the parameters of setting or cannot connect to your VoIP service provider.

Reset from Web Interface (Soft Reset)

This page allows user to configure dynamic network related parameters:

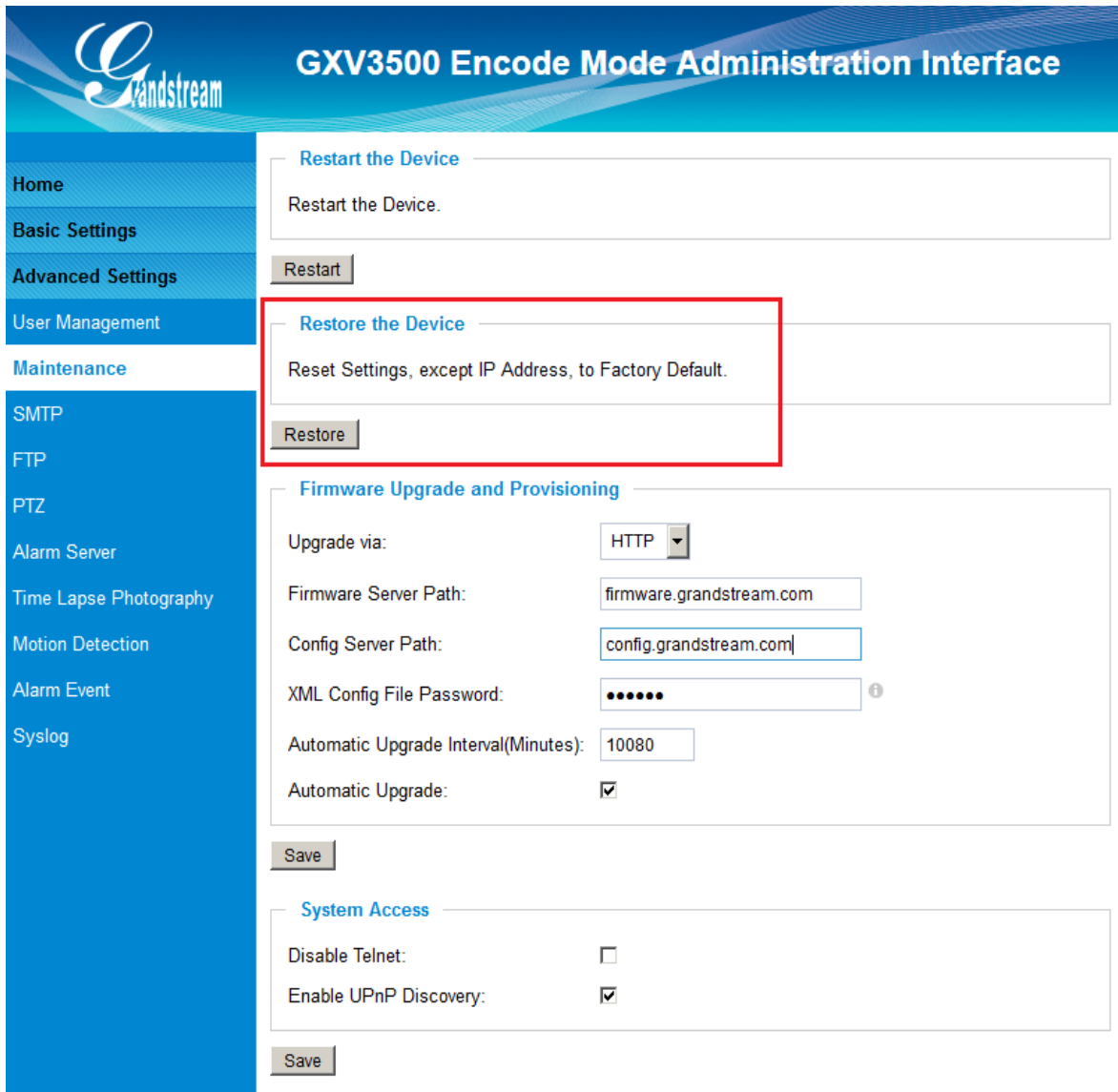

The screenshot shows the 'GXV3500 Encode Mode Administration Interface' with a left-hand navigation menu. The 'Restore the Device' section is highlighted with a red box. Below it, the 'Firmware Upgrade and Provisioning' section is visible, and at the bottom, the 'System Access' section is partially shown.

Section	Option	Description	Action
Restart the Device	Restart the Device.		Restart
	Restore the Device	Reset Settings, except IP Address, to Factory Default.	Restore
Firmware Upgrade and Provisioning	Upgrade via:	HTTP	
	Firmware Server Path:	firmware.grandstream.com	
	Config Server Path:	config.grandstream.com	
	XML Config File Password:	••••••	
	Automatic Upgrade Interval(Minutes):	10080	
	Automatic Upgrade:	<input checked="" type="checkbox"/>	
System Access	Disable Telnet:	<input type="checkbox"/>	
	Enable UPnP Discovery:	<input checked="" type="checkbox"/>	

Figure 27: Factory Reset from Web Interface

Reset via Button (Hard Reset)

To “hard” factory reset the camera, with the camera powered on, press and hold the “reset” button for 15 seconds until the IP camera reboot. The internal small red power LED will illustrate “On → Off → On”, meaning a successful hard factory reset.

Please refer to [Page 13](#) for the graphic illustration of hard reset button.



GXV3500 Front View

1. *V_IN, BNC Interface*
2. *MIC_IN*
3. *RESET*

GXV3500 BNC interface, connect to analog camera as Video Input (Voltage: 1.0V p-p; Resistance 75 Ω)
3.5mm socket for external 3rd party microphone input.
PIN hole, press & hold for 15 seconds to factory reset the device.

This page intentionally left blank

GXV3500 HOME WEB PAGE (DECODER MODE)

Once click “Decode Home Page” from the Home page of the Encode mode, the device will prompt and reboot to switch itself from Encode Mode to Decode Mode.

Following Home Page of Decode Mode will be displayed once the device boots up:

Home Page (Decoder Mode)



Encoder Home Page | Configuration | Language

Decoder Settings

Stream Format: RTSP

Default Stream: 1

Enable Patrol:

Video Output Type: Auto or NTSC

Real Size:

Save Start Patrol

No.	Patrol	RTSP URL	User Name	Password	Description	Time(s)
1	<input type="checkbox"/>	http://50.241.100.67:10002/4	admin	•••••	GXV3672_FHD_36	15
2	<input type="checkbox"/>	rtsp://50.241.100.67:10001/4	admin	•••••••	GXV3611IR_HD	60
3	<input type="checkbox"/>	rtsp://192.168.22.112/4	admin	•••••	GXV3662HD	30
4	<input type="checkbox"/>	rtsp://192.168.22.110/4	admin	•••••	GXV3610_FHD	60
5	<input type="checkbox"/>	http://test.ipcam.com:8080	admin	•••••	VLC OK 3rd party IPC	60
6	<input type="checkbox"/>					60
7	<input type="checkbox"/>					60
8	<input type="checkbox"/>					60

Save

Figure 28: Decoder Home Page

Decoder Setting Page

- **Stream Format:**
 - RTSP: Format of the data stream to be decoded: Decode RTSP data stream format.
 - SIP Phone: Decode SIP Phone call (UDP streaming).
 - HTTP: Decode HTTP data stream. (similar to VLC Player)

- **Default Stream:** Select stream to be decoded, maximum 8 stream can be selected, but only one stream can be decoded at any given moment.
- **Enable Patrol:** Click to select whether to run the decoding in Patrol Mode
- **Video Output Type:** Analogue Video Output Mode: Auto to NTSC; Auto to PAL; NTST; PAL.
- **Real Size:** Select to display in Home Page the Real Size of the decoded video.

Decoder Setting Explanation:

- Patrol: Select to enable and add the stream to “Patrol” mode
- RTSP URL: Input the RTSP URL or HTTP URL stream for GXV3500 to decode
- User Name: User Name or ID if required to decode the related stream
- Password: Password if required to decode the related stream
- Description: Name used to describe or identify the stream decoded
- Times: Timer (in second) used in Patrol Mode for this particular stream

NOTE:

- *ONLY H.264 supported. GXV3500 can NOT decode MJPEG stream*
 - *ONLY support D1 max. resolution. Therefore if remote side is Grandstream HD or FHD camera, it can NOT be displayed to TV output due to analogue limitation.*
 - *The maximum decoding resolution is: 704x576, 704x480, 640x480.*
 - *For most Grandstream HD/FHD IP camera, this means GXV3500 will ONLY decode the second data stream, it can NOT decode resolution more than D1 or VGA, because of the limitation of analogue interface output.*
 - *For 3rd party camera, the best way to try whether GXV3500 can decode it or not is using VLC Player to decode the 3rd party camera.*
 - *If VLC can NOT decode and display the 3rd party stream, then GXV3500 will NOT do it either.*
 - *VLC is Open Source media player, you can get from: <http://www.videolan.org/vlc/index.html>*
-
- ❖ VideoLAN, VLC, VLC media player and x264 are trademarks internationally registered by the [VideoLAN non-profit organization](#). VideoLAN software is licensed under various open-source licenses: use and distribution are defined by each software license.

BASIC SETTINGS EXPLANATION (DECODER MODE)

System Setting Page (Decoder Mode)

The screenshot displays the 'GXV350 Decode Mode Administration Interface' with a sidebar menu on the left containing: Home, Basic Settings, System, Networking, DDNS, SIP, Status, and Advanced Settings. The main content area is divided into three sections:

- Set the System Time:**
 - Current System Time: 2016-05-09 15:47:39 (Buttons: Sync With PC, Set Manually)
 - Time Zone: GMT-05 (New York, Toronto, Washington DC)
 - Enable Daylight Saving Time
 - Start Time: Mar, Second, Sunday, 2 Hour
 - End Time: Nov, First, Sunday, 2 Hour
 - Enable NTP
 - NTP Server: time.nist.gov
 - NTP Update Interval(Minutes): 1440 (5-1440)
- OSD Date Format:**
 - OSD Date Format: MM/DD/YYYY
- DI and DO:**
 - Digital input: Normal Open ; Current state is Open
 - Digital output: Normal Open ; Current state is Open
 - Alarm Output Duration: Always

Each section includes a 'Save' button at the bottom.

Figure 29: System Page (Decoder)

- **Current System Time:**
 - **Sync with PC:** Display time current system is running at
Click to synchronize current time with computer.
 - **Set Manually:** Click to manually set the current time and date.
- **Time Zone:** Select from pull down menu the time zone unit located
 - Enable DST: Configure Day Light Saving Time
 - NTP: Enable and configure NTP server and update interval.

- **On Screen Display (OSD)**
 - Date Format:** Format to display the OSD date
 - OSD Date Format: OSD Date format, choose based on user preference.

- **Device Name Setting:** Set the name of the camera which will be shown in the result of “Search Tool” of GSurf_Pro VMS program.

- **DI and DO:** DI and DO initial status for Alarm In or Out operation.
 - Digital Input: State of Digital Input, normal at Open state
 - Digital Output: State of Digital Output, normal at Open state
 - DO Duration: Select operation of Alarm Output Duration from pull down list.

Networking Setting Page (Decoder Mode)

This page allows user to configure network related parameters:



The screenshot shows the 'GXV3500 Decode Mode Administration Interface' with a sidebar menu on the left containing: Home, Basic Settings, System, Networking, DDNS, SIP, Status, and Advanced Settings. The main content area is titled 'IP Address Configuration' and includes three sections:

- IP Address Configuration:**
 - Dynamically Assigned via DHCP
 - Statically Configured as:
 - IP Address: 192.168.22.184
 - Subnet Mask: 255.255.255.0
 - Default Gateway: 192.168.22.1
- DNS Configuration:**
 - Obtain DNS Server Address Automatically
 - Use the Following DNS Server Address:
 - Primary DNS Server: 192.168.22.5
 - Secondary DNS Server: 8.8.8.8
- HTTP:**
 - HTTP Port: 80

A 'Save' button is located at the bottom left of the configuration area.

Figure 30: Networking Page (Decoder)

- **IP Address Configuration:**
 - Dynamically Assigned via DHCP: Camera IP address configuration. Default setting, DHCP server assign IP to camera.
 - Statically Configured as: Static IP address configuration (Preferred for Port FWD)
- **DNS Configuration:** DNS server IP. Must be configured if using static IP.
- **HTTP:** Web access TCP port, default 80.

NOTE:

- *If camera behind SOHO router with port forwarding configuration for remote access, static IP or static DHCP has to be used to avoid IP address change after router reboot.*
- *TCP port above 5000 suggested if Port Forward HTTP for remote access, due to some ISP would block port 80 for inbound traffic. For example, change the default HTTP port from 80 to 8088, to make sure the TCP port not likely blocked.*
- *In addition to HTTP port, RTSP port is also required to configure via port forward, so remote party can view the video stream.*
- *If revise the default TCP port 80 to port "A", then RTSP port should be "2000+A" (changed from default TCP 554). Both TCP port "A" and "2000+A" should be configured for port forwarding in the router. For example, the HTTP port changed to 8088, the RTSP port now should be 10088, both TCP ports 8088 and 10088 should be configured for port forwarding in order for remote camera access: 8088 for web portal, 10088 for video streaming.*

DDNS Setting Page (Decoder Mode)

This page allows user to configure dynamic DNS related parameters:

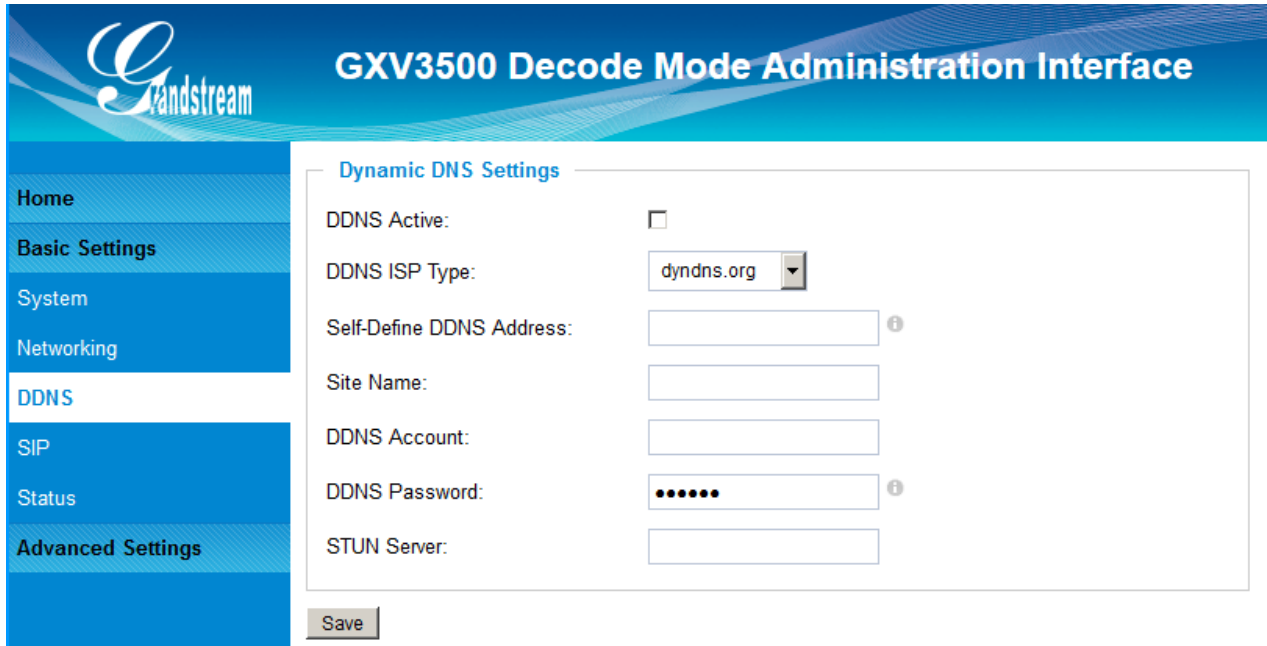
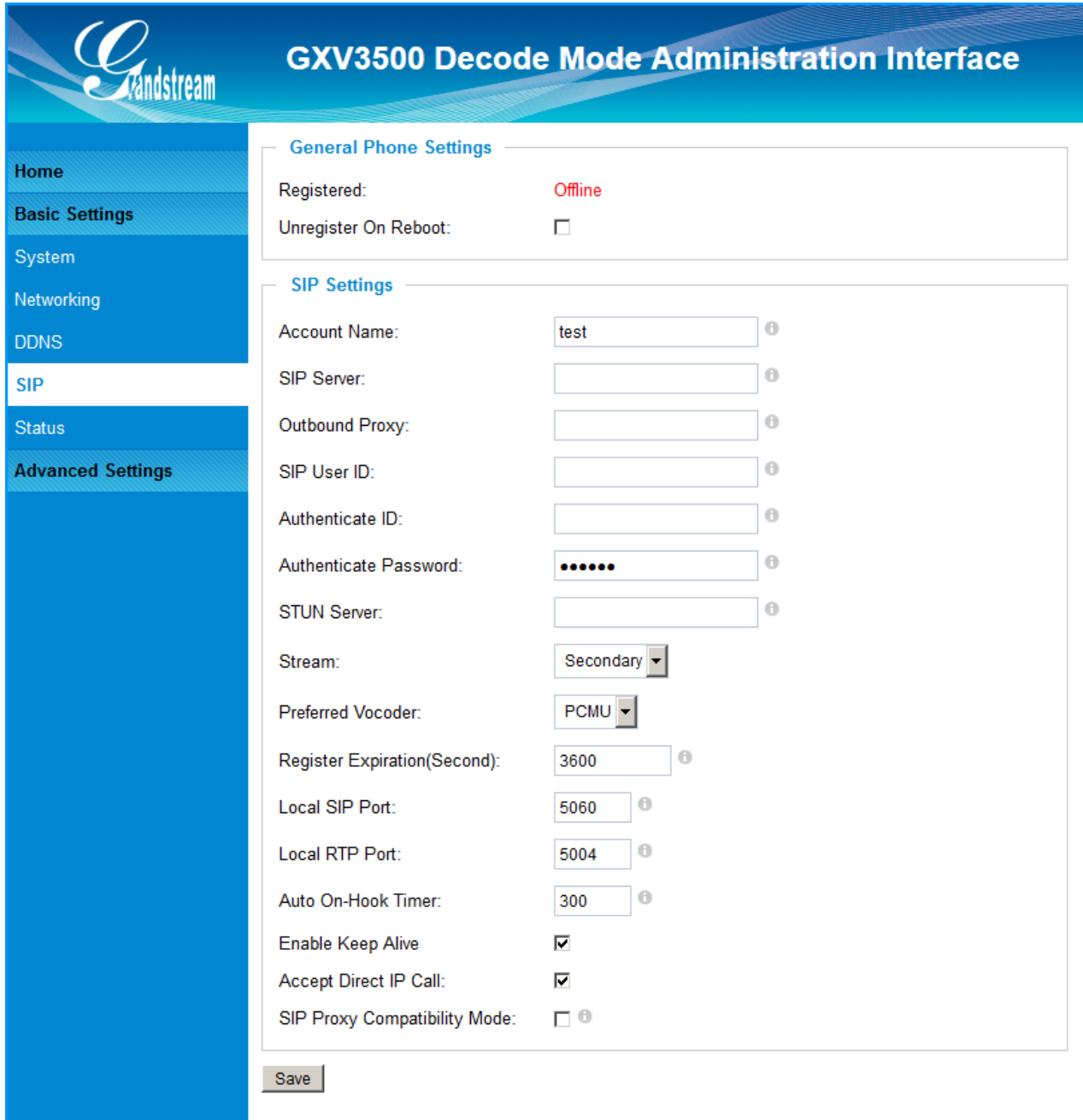

Figure 31: DDNS Setting Page (Decoder)

- **DDNS Active:** Enable DDNS by check this field.
- **DDNS ISP Type:** Select the DDNS service provider from the pull-down menu list
- **Self-Define DDNS Address:** Input the self-defined DDNS address
- **Site Name:** DDNS site name
- **DDNS Account:** DDNS account name
- **DDNS Password:** DDNS password
- **STUN Server:** Stun server FQDN or IP. If device behind a non-symmetric router, STUN server can help to penetrate & resolve NAT issue.

SIP Setting Page (Decoder Mode)

GXV3500 decoder can be configured as SIP endpoint to decode the video SIP call, showing remote SIP video phone or IP camera during SIP video call and displaying to audio and video to the connected big screen TV set.



The screenshot displays the 'GXV3500 Decode Mode Administration Interface' with a sidebar menu on the left containing: Home, Basic Settings, System, Networking, DDNS, SIP (highlighted), Status, and Advanced Settings. The main content area is divided into two sections: 'General Phone Settings' and 'SIP Settings'.

General Phone Settings

- Registered: Offline
- Unregister On Reboot:

SIP Settings

- Account Name: test
- SIP Server: [Empty]
- Outbound Proxy: [Empty]
- SIP User ID: [Empty]
- Authenticate ID: [Empty]
- Authenticate Password: [Masked]
- STUN Server: [Empty]
- Stream: Secondary
- Preferred Vocoder: PCMU
- Register Expiration(Second): 3600
- Local SIP Port: 5060
- Local RTP Port: 5004
- Auto On-Hook Timer: 300
- Enable Keep Alive:
- Accept Direct IP Call:
- SIP Proxy Compatibility Mode:

A 'Save' button is located at the bottom left of the settings area.

Figure 32: SIP Setting Page (Decoder)

- **Registered:** SIP registration status. Display “Online” in Green, “Offline” in Red.
- **Unregistered on Reboot:** If checked and SIP server support, reboot camera will unbind all registered end points using this SIP account.
- **Account Name:** SIP account name used for self identification.
- **SIP Server:** FQDN or IP of SIP server from VoIP service provider
- **Outbound Proxy:** IP or FQDN of Outbound proxy server, helps penetrate NAT/Firewall
- **SIP User ID:** SIP username, or telephone number from ITSP
- **Authenticate ID:** Authenticate ID used by SIP proxy
- **Authenticate Password:** Authenticate password used by SIP proxy
- **STUN Server:** STUN server used to resolve NAT if have
- **Stream:** Which stream used for SIP call. **Default 2nd stream and only 2nd stream**
- **Preferred Vocoder:** Audio codec used for SIP call, only G.711 A or U supported.
- **Registration Expiration:** Registration expiration time, default 3600 seconds
- **Local SIP Port:** Local SIP port, default 5060
- **Local RTP Port:** Local RTP port for media, default 5004
- **Auto On-Hook Timer:** Timer (in seconds) for automatic disconnecting the SIP call. Default 300.

- **Disable Audio in SIP Call:** Disable or turn off audio of camera when SIP call established.
- **Enable Keep Alive:** Checked to help NAT resolution, sending alive packets.
- **Accept Direct IP Call:** Check to accept peer-to-peer IP call in LAN without SIP server.
- **SIP Proxy Compatibility Mode:** Check to enable more proxy compatibility with cost of bandwidth, the SIP call will send both audio and video no matter what.

Status Page (Decoder Mode)

This page shows the GXV3500 Decode Mode operation status:

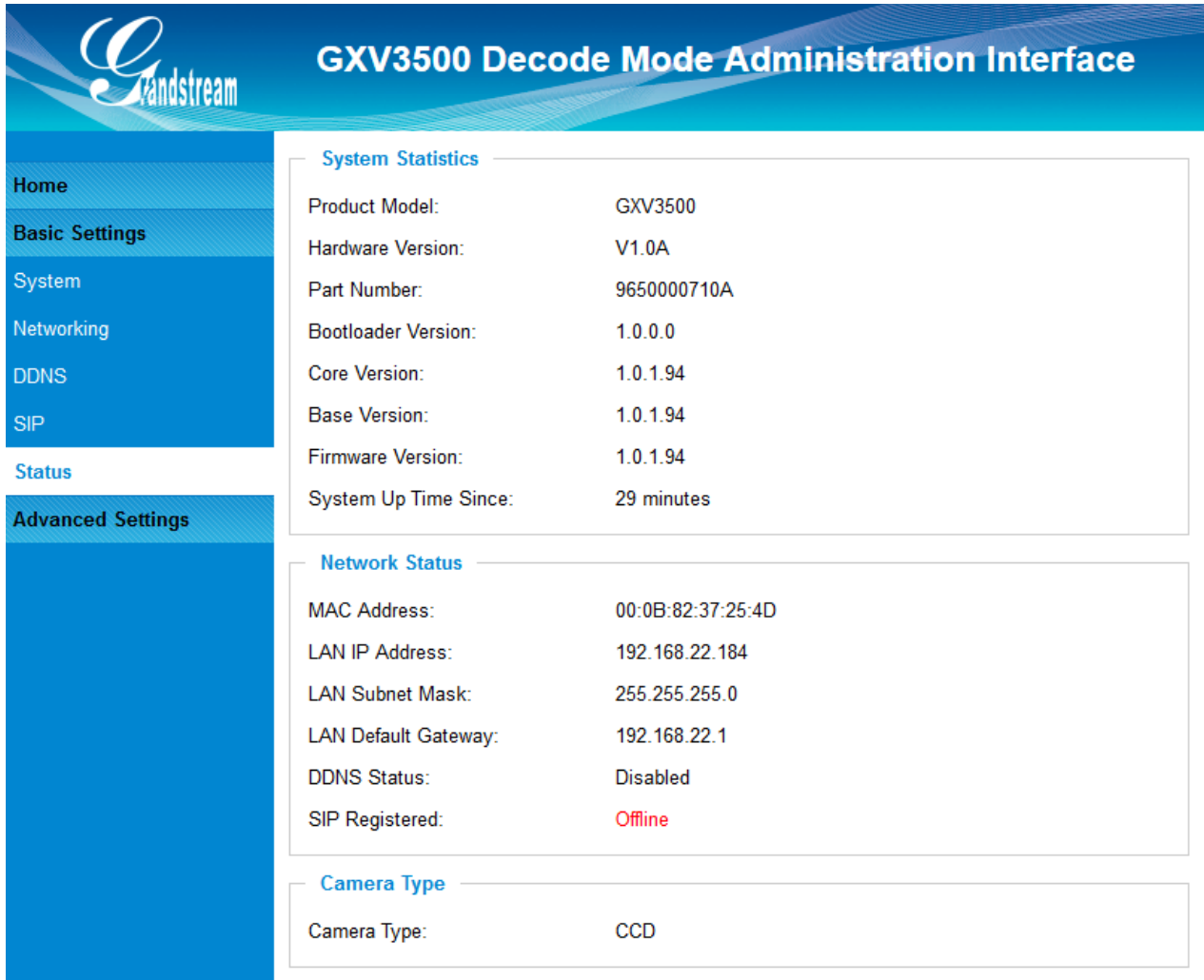

System Statistics	
Product Model:	GXV3500
Hardware Version:	V1.0A
Part Number:	9650000710A
Bootloader Version:	1.0.0.0
Core Version:	1.0.1.94
Base Version:	1.0.1.94
Firmware Version:	1.0.1.94
System Up Time Since:	29 minutes

Network Status	
MAC Address:	00:0B:82:37:25:4D
LAN IP Address:	192.168.22.184
LAN Subnet Mask:	255.255.255.0
LAN Default Gateway:	192.168.22.1
DDNS Status:	Disabled
SIP Registered:	Offline

Camera Type	
Camera Type:	CCD

Figure 33: Status Page (Decoder)

NOTE:

- When SIP account registered, the status will display “Online” in Green.
- When SIP account unregistered, the status will display “Offline” in Red, as below.

SIP Registered: Offline

ADVANCED SETTINGS EXPLANATION (DECODER MODE)

User Management Page (Decoder Mode)

This page allows customer to configure the user and related privilege

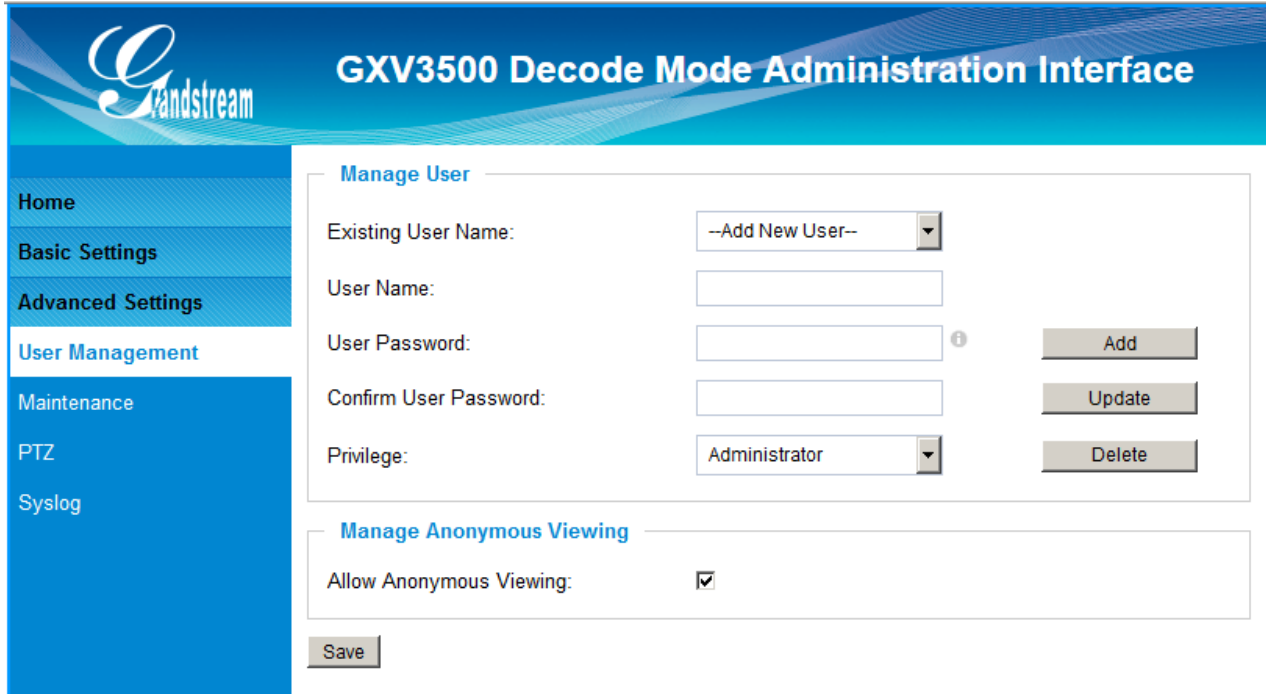

Figure 34: User Management Page (Decoder)

- **Existing User Name:** Allow revise existing user or add new user
- **User Name:** The name of users need to be revised
- **User Password:** New password if revise password
- **Confirm User Password:** Re-enter the new password for verification, must match.
- **Privilege:** Choose user privilege. Two levers: Administrator, Viewer. Viewer cannot change any settings.

Manager Anonymous Viewing

- **Allow Anonymous Viewing:** When checked, no security enhanced. Any person can view the camera if knowing the IP or FQDN of the camera, but cannot change anything, just view ONLY.

Maintenance Page (Decode Mode)

This page allows user to maintain the GXV3500 in Decode Mode:



Figure 35: Maintenance Page (Decoder)

- **Restart:** When clicked, the camera will reboot or restart (soft reboot).
- **Restore:** When clicked, the camera will be reset to factory default, wiping out all the configurations (except IP address)
- **Upgrade via:** Upgrade firmware via TFTP, HTTP or HTTPS
- **Firmware Server Path:** Server path holding the firmware
- **Config Server Path:** Server path holding the configuration file (auto provisioning)
- **XML Config File Password:** Password for encrypt the XML based configuration file

- **Automatic Upgrade Interval (Minutes):** Time interval for automatic upgrade, default 10080
- **Automatic Upgrade:** Checked to enable automatic firmware upgrade and provisioning.

System Access

- **Disable Telnet:** Check to disable Telnet to enhance security.
- **Enable UPnP Discovery:** Used for UPnP automatic discovery of the device in related network environment. Default enabled.

NOTE:

- *Only XML based automatic provisioning is supported by GXV3500.*

PTZ (Decode Mode)

This page allows user to configure GXV3500 (decode mode) to use its related RS-485 port as output control of 3rd party PTZ compatible device or TEXT output device via RS-485 port.

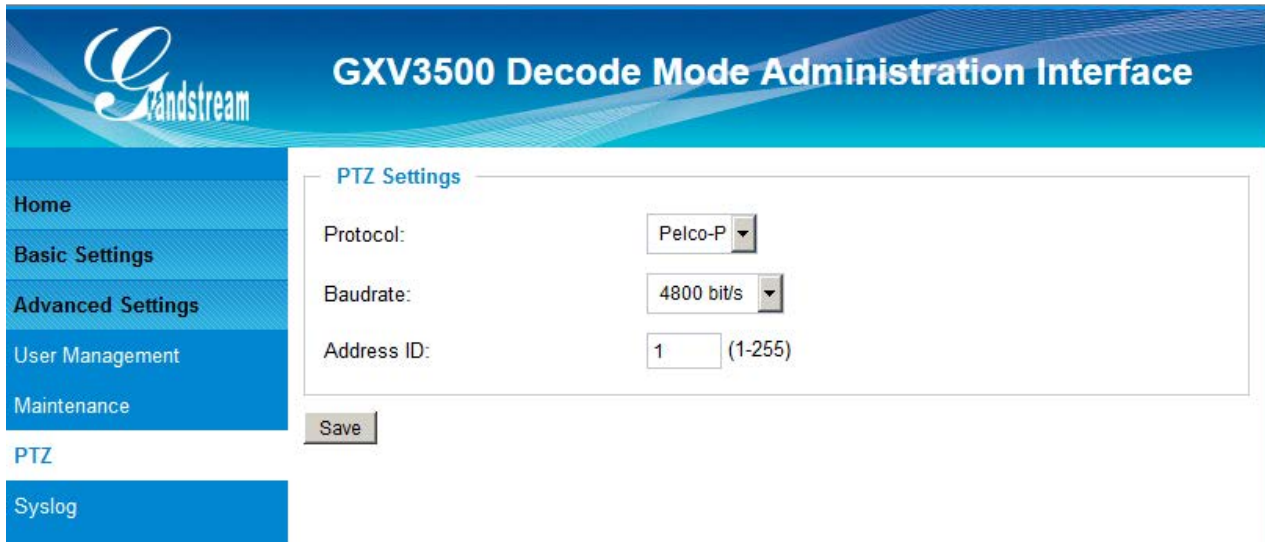

The screenshot shows the 'GXV3500 Decode Mode Administration Interface'. On the left is a navigation menu with options: Home, Basic Settings, Advanced Settings, User Management, Maintenance, PTZ (highlighted), and Syslog. The main content area is titled 'PTZ Settings' and contains three configuration fields: 'Protocol' set to 'Pelco-P', 'Baudrate' set to '4800 bit/s', and 'Address ID' set to '1' (with a range of '(1-255)' shown). A 'Save' button is located below these fields.

Figure 36: PTZ Configuration Page (Decoder)

- **Protocol:** Pull-down to select supported PTZ protocol by connected analogue camera. Only Pelco-D or Pelco-P allowed.
- **Baudrate:** The baudrate used by the analogue camera interface, select from the pull-down menu.
- **Address ID:** Hardware Pelco-D or Pelco-P address ID used by the analogue camera, please refer to related camera user manual for this ID (or PIN switch in the UM), then fill in related matching address into this field.

NOTE:

- *The address ID has to be same and match the one used in the connected analogue camera. Otherwise the PTZ will not function or behave abnormal due to the wrong Pelco-D or Pelco-P address used.*
- *Detailed information of passing TEXT or CMD via RS-485 port, please refer to related 3rd party device connected, or refer to HTTP API for more information:*
http://www.grandstream.com/sites/default/files/Resources/grandstream_http_api_1.0.0.54.pdf

Syslog Settings (Decode Mode)

This page allows user to enable the Syslog to help troubleshooting problems.

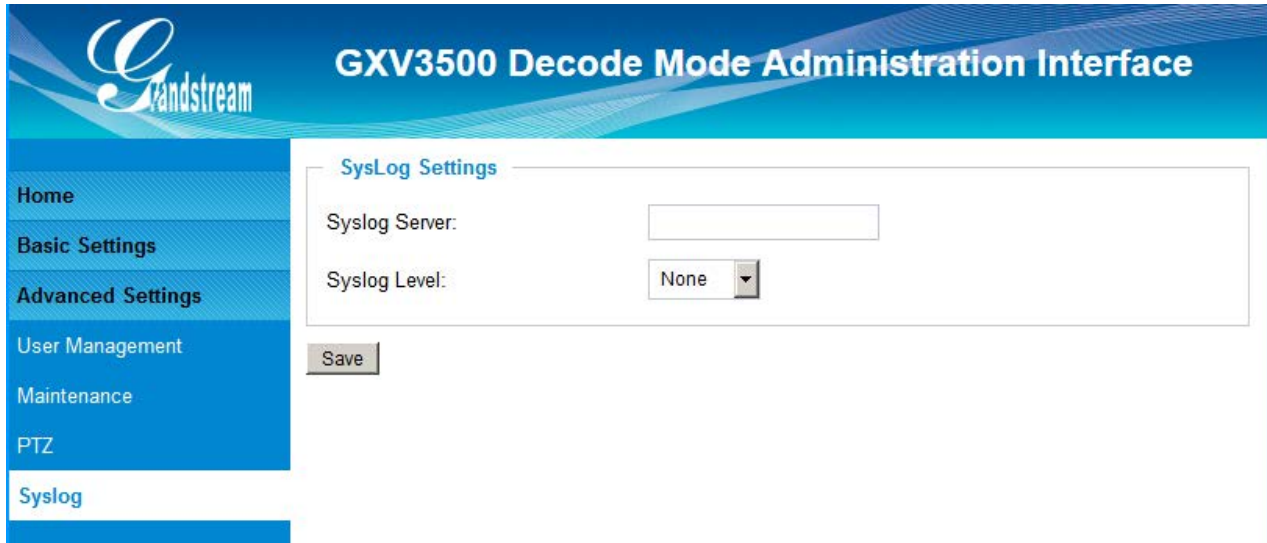

The screenshot shows the 'GXV3500 Decode Mode Administration Interface' with a sidebar menu on the left containing: Home, Basic Settings, Advanced Settings, User Management, Maintenance, PTZ, and Syslog. The main content area is titled 'SysLog Settings' and contains two input fields: 'Syslog Server:' with an empty text box, and 'Syslog Level:' with a dropdown menu currently set to 'None'. A 'Save' button is located below the 'Syslog Level' dropdown.

Figure 37: Syslog Page (Decoder)

- **Syslog Server:** Syslog server IP or Domain Name
- **Syslog Level:** Lever of syslog message sent to the syslog server:
None, Debug, Info, Warning, Error.

REMOTE ALARM_OUT PEERING WITH GXV3500 (DECODER MODE)

The IP66 weather-proof IP cameras GXV3672, GXV3674 and GXV3610 series do not have built-in Alarm_Out interface, but when peering with Grandstream GXV3500 encoder/decoder, the GXV3500's built-in Alarm_Out interface (*running at decoder mode*) can behave as remote Alarm_Out for those IP Cameras.

The benefit of such peering is the Alarm_Out circuit is not physically wired into the IP Camera anymore, with the Ethernet network behaving as wiring, the Alarm_Out circuit can now be located to convenient places where GXV3500 located. This means IP Camera can be in location A, while the Alarm_Out can be in location B (A and B can be in the same or different places as long as A and B can reach each other via network/internet). This will help a lot of users to monitor site remotely and take appropriate action, because there are situations where location A with cameras but actions have to be taken from location B. With Grandstream's solution, traditional A and B limitation by the cable length is now disappear.

The configuration of such remote Alarm_Out is very simple:

GXV3672/GXV3674/GXV3610 Side:

Same configuration as previous Motion Detection configuration, just make sure "Upload to Alarm Center" checked and selected:

Alarm Action

Record Video From Pre Alarm Up to 10 seconds to After Alarm Up to 30 seconds ⓘ

Voice Alarm to SIP Phone

Upload to Alarm Center

Upload to Alarm HTTP Server

Record Video and Upload to FTP Server

Email and FTP upload JPEG

Pre Alarm Up to 1 seconds to After Alarm Up to 0 seconds

Figure 38: Remote Alarm_Out IP Camera Configuration

GXV3500 (Decode Mode) Side:

GXV3500 has to be running as **Decode Mode** when functioning as remote Alarm_Out of the peering IP Camera. The configuration is as below:

- 1) Input the **2nd stream** (*H.264 Only, MJPEG NOT supported*) as the RTSP URL, with correct credentials, as shown below.
- 2) Only ONE stream (currently decoding stream) the Motion Detection can use the GXV3500 built-in Alarm_Out interface if there are multiple RTSP URL configured in the GXV3500.

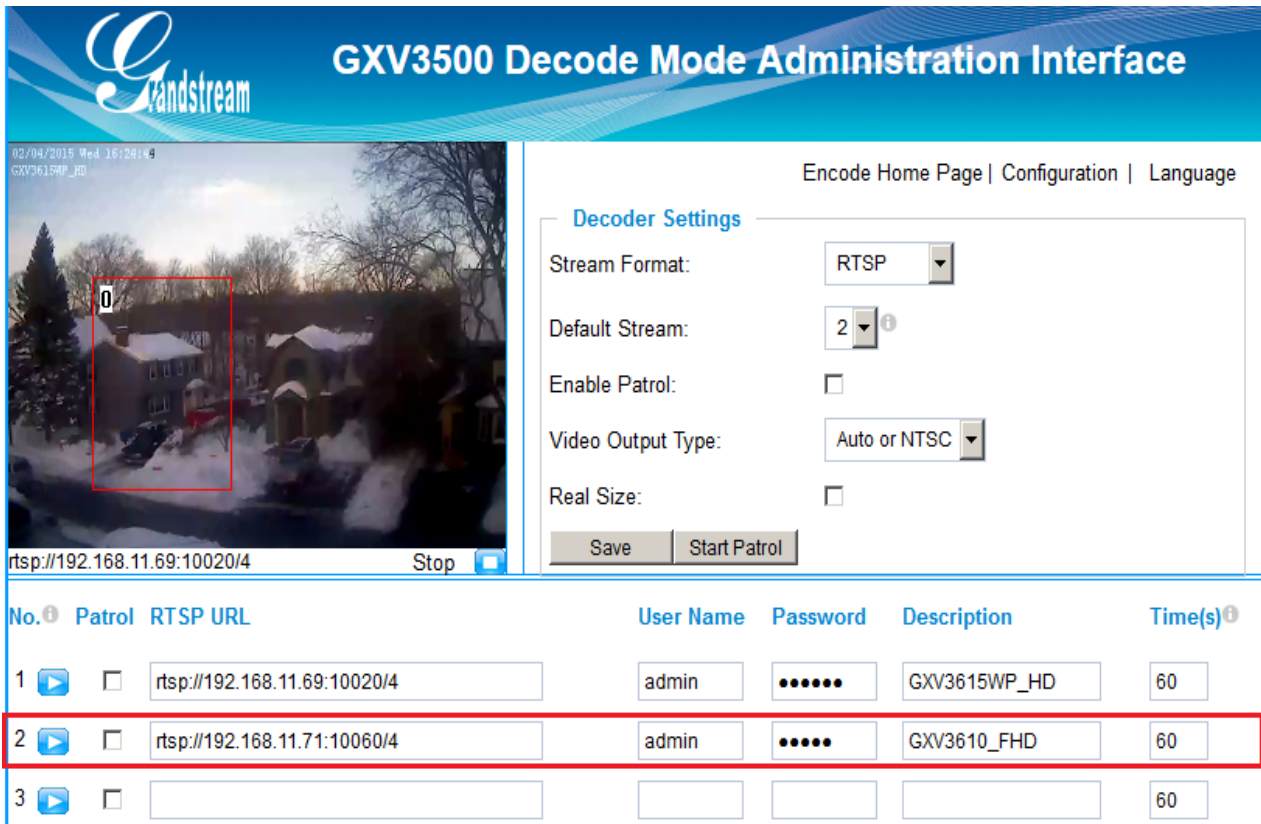

The screenshot shows the 'GXV3500 Decode Mode Administration Interface'. On the left, a video feed displays a snowy residential street with a red box highlighting a house. Below the video, the URL 'rtsp://192.168.11.69:10020/4' and a 'Stop' button are visible. On the right, the 'Decoder Settings' panel includes: Stream Format (RTSP), Default Stream (2), Enable Patrol (unchecked), Video Output Type (Auto or NTSC), and Real Size (unchecked). Below the settings is a table of configured RTSP streams.

No.	Patrol	RTSP URL	User Name	Password	Description	Time(s)
1	<input type="checkbox"/>	rtsp://192.168.11.69:10020/4	admin	•••••	GXV3615WP_HD	60
2	<input type="checkbox"/>	rtsp://192.168.11.71:10060/4	admin	•••••	GXV3610_FHD	60
3	<input type="checkbox"/>					60

Figure 39: Remote Alarm_Out peering GXV3500 Configuration

NOTE:

- GXV3500 is designed to work with **analogue camera**, with **maximum decode resolution 704x576**, this is why 2nd stream decoding used as peering for remote Alarm_Out. The RSTP setting will be:

rtsp://IPCamera:Port/4 (4 is 2nd stream of GXV3672/GXV3674/GXV3610)

- 2nd stream also consume less bandwidth therefore good for internet transmission.
- H.264 video codec has to be selected because Motion Detection not supported via MJPEG.
- All Grandstream IP Cameras without built-in Alarm_Out interface can peer with GXV3500 (Decoder Mode) built-in Alarm_Out interface for Motion Detection Remote Alarm_Out.

Alarm_Out duration can be configured at “System” setting page of GXV3500 Decoder. See below the figure. When Alarm_Out taking action, the webpage will show the related action.

For example, below the “Digital Output Duration” is selected as “15 seconds” so the Alarm_Out will act for 15 seconds before revert back to previous state. In below case, the default is circuit “Open”, when Motion Detection alarm triggered, the circuit state changed to “Close”, as illustrated below for 15 seconds and then switch back to previous “Open” state.

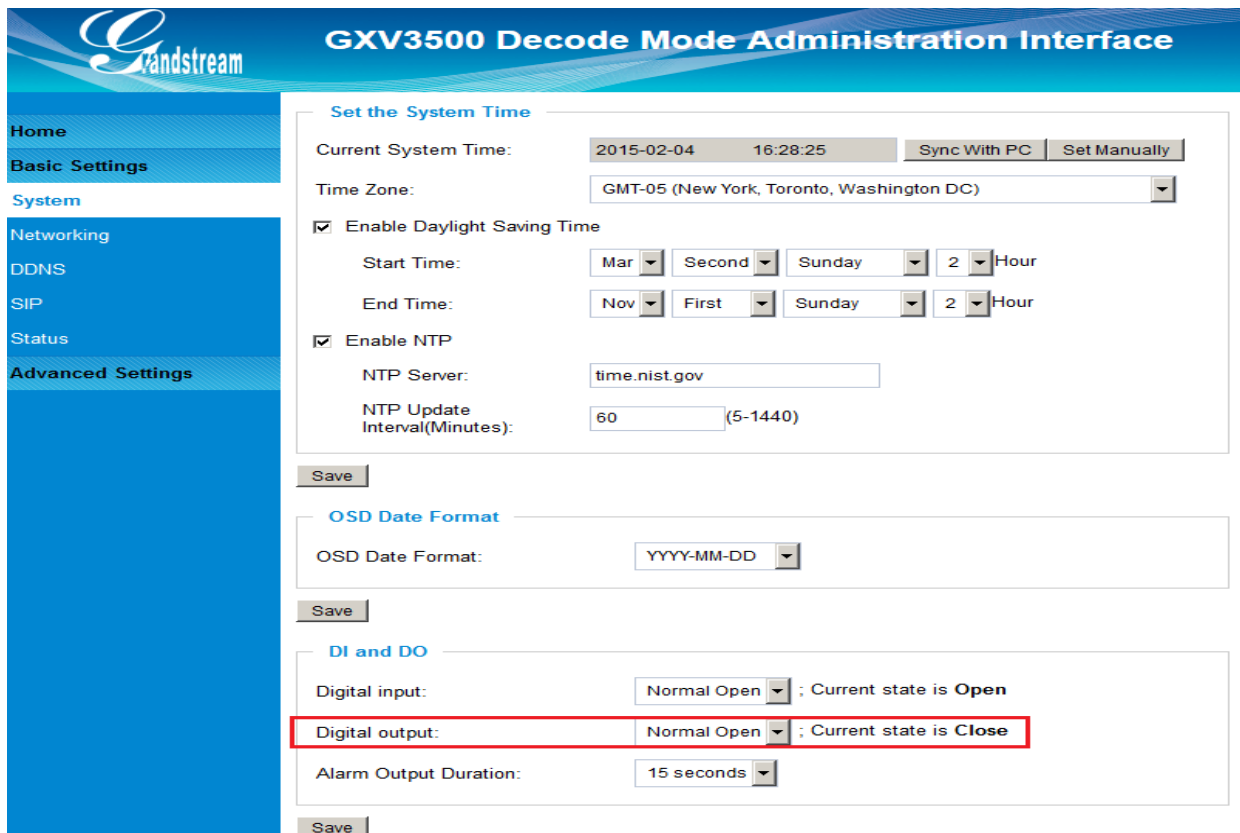

The screenshot shows the 'GXV3500 Decode Mode Administration Interface' with a left-hand navigation menu. The 'System' section is active, displaying the following settings:

- Set the System Time:**
 - Current System Time: 2015-02-04 16:28:25 (Buttons: Sync With PC, Set Manually)
 - Time Zone: GMT-05 (New York, Toronto, Washington DC)
 - Enable Daylight Saving Time
 - Start Time: Mar Second Sunday 2 Hour
 - End Time: Nov First Sunday 2 Hour
 - Enable NTP
 - NTP Server: time.nist.gov
 - NTP Update Interval(Minutes): 60 (5-1440)
- OSD Date Format:**
 - OSD Date Format: YYYY-MM-DD
- DI and DO:**
 - Digital input: Normal Open ; Current state is Open
 - Digital output: Normal Open ; Current state is Close** (highlighted with a red box)
 - Alarm Output Duration: 15 seconds

Figure 40: Remote Alarm_Out peering GXV3500 Action Output Display

Unlike the Alarm_Out interface of Grandstream IP Camera (e.g.: GXV3611IR_HD or GXV3662_HF/FHD where the related Alarm_Out interfaces are using relay switch), the GXV3500 Alarm_Out is using photocoupler circuit.

If connecting to a multimeter, you will see the Ohm changed from unlimited to several hundred Ohms depending on GXV3500 HW version.

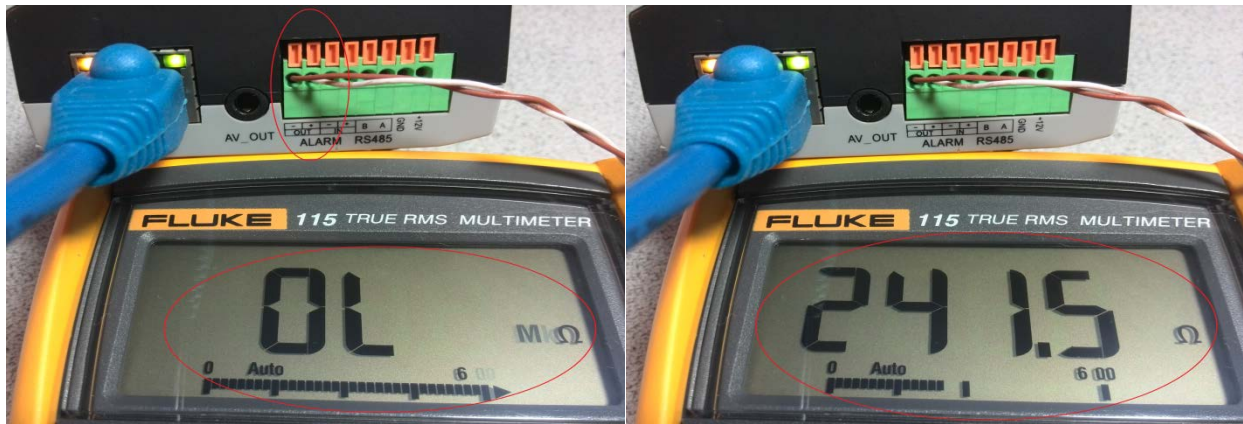
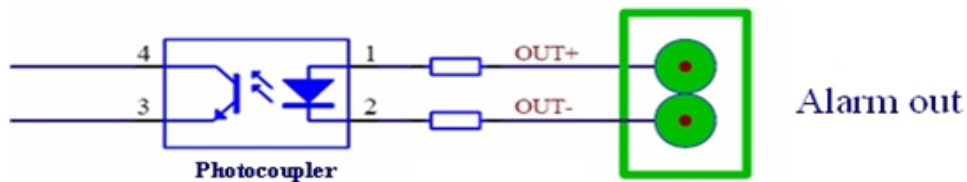

Figure 41: Peering GXV3500 Decoder Alarm_Out Circuit

The above method can be used for installers to check the functionality of this feature at lab or on field before the installation.

With the help of GXV3500 Decoder, customers can now free from the wiring limitation and have the Alarm_Out feature for Grandstream IP66 weather-proof IP cameras.

IP SURVEILLANCE FAQ

1. What is the default IP address of the GXV3500?

The default IP configuration is DHCP or 192.168.1.168 after booting up 5 minutes.

2. Why can I not view the live video stream in Microsoft Internet Explorer?

Please double check whether the Grandstream Plug-in/Active-X is installed correctly.

Once you log into the GXV3500 web interface, Internet Explorer will indicate that this website wants to install the following add-on: "GSViewer.cab" from Grandstream Networks, Inc. Please install this add-on when prompted by IE.

3. How do you manually uninstall the Grandstream video viewer add-on for IE?

Please follow these steps to uninstall the add-on:

1. Delete the *GSViewerX Control* from *C:\WINDOWS\Downloaded Program Files* directory
2. Delete *GSNetClient.dll*, *GS_Replay.exe*, *GSViewerX.ocx*, *hi_h264dec_w.dll*, *lik_VoiceEngine_dll.dll* and *GSViewerX.inf* from *C:\WINDOWS\system32*

4. Why can't I access the GXV3500 web configuration interface?

Q 1: Is your internet service down?

A 1: Connect a PC to the internet to test the connection.

Q 2: Are the PC and the device in different subnets?

A 2: Check the subnet mask and default gateway of the device and PC.

Q 3: Is there a conflict with another IP address?

A 3: Try to change the IP address of the device.

Q 4: Has the HTTP port been changed?

A 4: Contact the administrator of the device for more information.

5. The GXV3500 web configuration page is not displayed correctly in IE8 ?

In IE8, Compatibility View might need to be enabled for the GXV3500 web configuration page to load properly. To enable compatibility view, open IE8, click *Tools, Compatibility View Setting*, and add the GXV3500 web configuration pages to the Compatibility View.

6. Why does IE indicate to install Grandstream Video Viewer add-on after a firmware upgrade? The add-on was properly installed before the firmware upgrade process.

New firmware will often upgrade the add-on as well. To watch the live video stream, you must install the newest version of the add-on.

7. How do you watch secondary video stream?

Login to the home page of the GXV3500 web GUI, click Play to watch the video stream. To watch a secondary video stream, right click on the video, and select *Secondary Stream* on the pop-up menu. Try reinstalling the Grandstream Viewer add-on for IE if you cannot see the video stream.

8. What is DDNS? Is it important for IP surveillance product to have DDNS support?

DDNS is an acronym for Dynamic Domain Name Service. It is important to choose an IP network camera that has DDNS support for dynamic IP addresses. Chances are that the network has a dynamic IP address (which changes with every log on). A DDNS service makes sure that the camera's IP address always matches up to the current server address. DDNS also allows a website to be linked to the IP camera that is constantly updated with the correct information and has a reliable feed.

9. Why is Windows Media Player unable to play the recorded video files?

The GXV3500 uses the H.264 video codec. Windows Media Player may lack the proper H.264 decoder to play the recorded video. Please download the Microsoft FFDSHOW H.264 decoder from <http://sourceforge.net/projects/ffdshow-tryout/> and install it.

10. Alarm Triggered Events do not work with GSurf_Pro?

Please double check the Alarm Action on your GXV3500. Login to the web GUI of the GXV3500, go to the Motion Detection or Alarm Events page, and make sure option Upload to Alarm Center is checked.

11. Recommended to save the video files in different directories when using GSurf_Pro?

It is better to save video files in different directory to prevent accidental deletion of the recorded files you need.

12. How to use a cell phone to watch the GXV3500 video stream?

You must set the video resolution to QCIF to watch the GXV3500 video stream from a cell phone. Make sure to set the bit rate to 64kbps to ensure the best video quality.

13. What Smartphone application should I use to view the video?

There are free applications and paid version application for this, you can find them in Google Play for Android phone and Apple Store for iPhone, like: IP Cam Viewer:



<http://hit-mob.com/>

14. Why the IP address of the device NOT reset when clicking the “Restore” button?

The GXV3500 could be installed in areas that are not easy to access. For example, it could be installed on the roof of a building or the ceiling of an office. This makes it difficult to reinstall the device, therefore the “Restore” function will not clear the IP address.

15. Why can’t the live video stream be viewed using a mobile phone or GSurf_Pro after changing the HTTP Port of the device?

Make sure that the RTSP port of the device is set to 2000 plus the HTTP Port number. For example, if the HTTP port is 88, then the RTSP port of the device that you configured on GSurf_Pro or mobile phone should be 2088.

16. Port forwarding

Two ports must be forwarded on your router to watch video from a GXV3500 that is located on a private network from a PC in a public network. The web port (HTTP) and the RTSP port. Please make note that the RTSP port number changes according to the web port. If the web port is 80, then the RTSP port is 554. If the web port is not 80, then the RTSP port equals the web port +2000. For example, if the web port is 88, then the RTSP port will be 2088.

17. What is the “Pin Out” for the 3.5mm AV cable used in GXV3500?

The “Pin Out” layout for the supplied 3.5mm AV cable used in GXV3500 is the 1st one (highlight in **Blue**) in below table.

Basically: **1: Ground; 2: Video (Yellow); 3: Audio Right (Red); 4: Audio Left (White).**

Same as the AV cable used in Apple iBook.

3.5mm 4-Pole to RCA

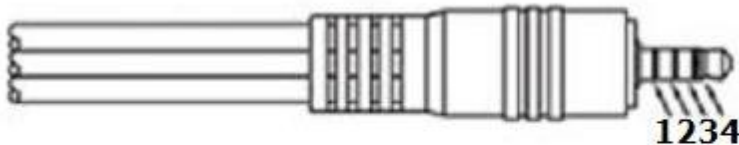

	1	2	3	4
Archos, Gigabeat, Creative Zen Vision Series, Cown iAudio, Apple iBook	Ground	Video	Right	Left
Standard Camcorder Cable, Topfield TFP20, Maxian T600	Right	Ground	Video	Left
iPod Video	Video	Ground	Left	Right
Zune	Video	Ground	Right	Left

17. Will the GXV3500 Decoder/Encoder be compatible with third party cameras?

- *Encode Mode: (Analogue Camera)*

Generally, most 3rd party analogue cameras will be digitized to IP Camera when connecting to GXV3500 BNC port at Encode Mode.

- *Decode Mode: (IP Camera)*

Whether GXV3500 can decode the data stream from a 3rd party IP camera is dependent on how the stream was encoded. GXV3500 utilizes the RTSP stream and is capable ONLY H.264 formats decoding (so MJPEG is out of luck). General rule of thumb is if the RTSP stream of 3rd party IP Camera can be viewed by [VLC Media Player](#) (free open source media player software), the GXV3500 will very likely be able to decode the stream, but no guarantee due to the variety of H.264 encoding implementation by different IP Camera vendors.